

# Using Model-Based Calibration Toolbox Multimodels for Cycle-Optimized Diesel Calibration

**Joshua P. Styron**  
Ford Motor Company

## ABSTRACT

Modern diesel engines have many degrees of freedom that must be simultaneously adjusted to optimize efficiency, emissions, and performance. Model-Based Calibration Toolbox™ from The MathWorks has been used to fully optimize a base-engine calibration to meet cycle-based emissions and fuel economy targets as well as local combustion noise targets and mechanical limits. Multimodels were used to build a collection of local models that behave as global models at the discrete speed/load test points. This facilitates the use of sum constraints to represent drive cycles and gradient constraints to ensure smooth calibration tables.

## INTRODUCTION

Modern diesel engines have many degrees of freedom that must be simultaneously adjusted to optimize efficiency, emissions, and performance. Due to the complexity of the interactions among the input parameters, it is not possible to decompose the calibration process into a set of smaller, simpler models. To meet drive-cycle emissions and fuel economy targets, tradeoffs must be made among various speeds and loads. Therefore, the drive-cycle-optimized solution is not the same as a collection of individually optimized speed and load operating conditions.

To project cycle-based emissions and fuel consumption, engine responses must be modeled at a number of speed/load operating conditions and integrated with appropriate weighting factors at each speed/load. Simply expanding local models by adding the two inputs to represent speed and load may result in a loss of fidelity as the models become too complex. A new global model type was needed to maintain maximum local model quality while allowing cycle-based tradeoffs to be assessed. Multimodels were introduced in Model-Based Calibration Toolbox to address this need. Multimodels essentially select the best local model at each speed and load operating point. These global models retain all of the fidelity of the local models, while allowing tradeoffs among discrete speed and load points in cycle optimizations.

In the Calibration Generation (CAGE) tool, multimodels were used to generate steady-state calibration set points for an entire engine map that minimize fuel consumption while simultaneously meeting cycle emissions and local NVH targets. In addition, many constraints were utilized to ensure the calibration was realistic. Map gradient constraints helped to ensure the resulting optimized maps would be smooth enough. Boundary constraints were used to limit the optimization to attainable points, while models of critical engine limits such as peak cylinder pressure and turbine inlet temperature ensure the calibration remains within the critical engine limits.

## OVERVIEW OF CALIBRATION PROCESS STEPS

This paper explores the essential steps required to generate a steady-state, base-engine diesel calibration. After this brief overview, each step is described in more detail.

Generic Calibration Steps:

1. Identify designed experiment (DoE) speed/load operating points and weighting factors.
  - a. Select load axis for experiments.
  - b. Cascade all relevant vehicle drive cycles to engine speed/load operating points.
  - c. Select speed/load break points for DoE.
  - d. Calculate time weights for each DoE speed/load point over each drive cycle.
2. Determine DoE factors and bounds for each DoE speed/load point.
  - a. Identify calibration factors to be varied.
  - b. Select appropriate ranges for each factor at each speed/load point.
  - c. Select size of DoE runs depending on model complexity.
3. Collect and prepare data for Model-Based Calibration Toolbox.
4. Build multimodels of engine responses and boundary models.
5. Optimize calibration.

- a. Optimize each speed/load independently for fuel economy, respecting independent constraints (noise, smoke, hydrocarbon emissions, combustion stability, and mechanical limits).
  - b. Optimize set of speed/load points collectively for cycle fuel economy while meeting cycle emissions and map gradient constraints in addition to independent constraints.
6. Export calibration tables and verify engine responses.

## DEFINE SPEED AND LOAD OPERATING POINTS

Depending on the engine certification path, this step may be predefined. For instance, dynamometer-certified engines certify emissions compliance with test cycles that depend on the maximum torque capability of the engine as a function of speed. For chassis-certified engines, however, this step is significantly more challenging. The certification requirements are defined at the vehicle level rather than at the engine level, so more information is needed to determine the corresponding engine operating conditions.

Early in vehicle programs, this additional information required to determine the engine speed/load over the vehicle drive cycles is likely to come from detailed vehicle simulations. However, it could also come from actual vehicle tests. In either case, the real or virtual vehicle must be "driven" over all of the important drive cycles and engine speed/load must be recorded as a function of time.

## SELECT LOAD AXIS

Engine load can be measured in many ways. Injected fuel quantity, percent of peak torque, brake torque, net indicated torque, and gross indicated torque are all acceptable measures of engine load. The choice of load axis influences the results of the mapping process and can introduce unexpected errors at different places in the process. The two items influencing the choice of load axis are the software strategy used to control the engine and the certification process. The choice of load axis affects test bed operation, optimization accuracy, and calibration table filling accuracy.

If the control strategy is defined in brake torque, the choice of DoE load axis is straightforward. If the control strategy is based on gross indicated torque, the choice becomes more complicated. Gross indicated torque is the torque the engine would generate over the compression and expansion strokes with no frictional losses. Sometimes gross indicated torque is referred to as *inner* torque as it is the work extracted from the gases *inside* the engine.

Consider this latter scenario where the control strategy is defined in gross indicated torque, and brake torque is chosen as the load axis. Holding brake torque constant during DoE testing is straightforward with the use of a closed-loop controller on dynamometer-measured torque. Because the drive-cycle load axis and the DoE load axis match, time weight factors can be applied directly. No additional errors are introduced during this optimization step as a result. The only issue with choosing brake torque as the load axis comes when actual calibration tables need to be filled. Because the load axes don't match, an interpolation routine must be used to convert from one load unit to the other. For revisiting DoE results when later investigating tradeoffs, great care must be exercised to ensure the friction of the engine hasn't changed. A fresh map of brake torque to gross indicated torque may need to be used to determine which DoE results apply to a given operating condition.

If gross indicated torque is chosen as the load axis, then interpolation errors are introduced at a different step in the process. The main advantage of working with the same load axis as the control strategy is in the simplicity of calibration table filling. The DoE results can be directly applied to the calibration tables. Further, identifying which DoEs apply to a given calibration issue is straightforward. For example, if an issue is discovered in vehicle testing, brake torque as measured on the engine dynamometer is not likely to be available.

Care must be exercised when applying time weights that were derived based on brake torque to DoE points taken at constant gross indicated torque. Mass flow engine responses that are used for cycle emissions and fuel economy assessments should be divided by the ratio of actual brake torque to the brake torque assumed when the time weights were calculated. Errors associated with this adjustment depend on how close the baseline engine map is to the final engine map. If some DoE points are below or near zero torque, this correction can lead to large errors. Therefore, mass-flow parameters near or below zero torque should not be adjusted.

Considering the overall goal of minimum model error, the choice of load axis still depends on the details of a given engine program. For a dynamometer-certified engine, having DoE models that match the heavily-weighted, regulated speed/load points offers advantages when trying to optimize the calibration for the regulated cycle. For a chassis-certified engine, however, the link between engine speed/load and the regulations is much less direct, so the advantage of direct calibration table filling may carry more weight. In this way, the errors are confined to the drive cycle representation rather than influencing both the drive cycle definition and table filling.

## CASCADE DRIVE CYCLES TO ENGINE OPERATING CONDITIONS

If the engine is destined to be dynamometer certified, this step is defined by the EPA based on the engine's rated torque curve. Weighting factors for the heavy-duty transient FTP, Supplemental Emission Test (SET, a.k.a. 13-mode), and Not-to-Exceed (NTE) testing are well defined and will not change as long as the engine torque curve is stable. As mentioned in the preceding section, the DoE points will likely be described in speed and brake torque.

For chassis-certified engines, vehicle models or actual vehicles must be used to translate drive cycles specified as vehicle speed versus time to cycles of engine speed and load versus time. Of course, this translation depends greatly on the definition of the vehicle and the fidelity of the vehicle model. If the vehicle definition changes, then this translation must be repeated. Further, if the load axis was chosen to be based on gross indicated torque, then the model must be extended to account for engine friction and pumping losses. This last translation could be based on detailed engine models or simply extracted from a representative engine map. In either case, the calibration will certainly affect this relationship. Therefore, it will be necessary to iterate through the optimization process with updated engine operating conditions based on the optimum calibration until convergence is achieved. Figure 1 shows engine speed and load points for the same vehicle on the same drive cycle, but with different transmission calibrations. The graph on the left is engine speed versus brake mean effective pressure (proportional to torque), and the graph on the right is engine speed versus gross indicated torque.

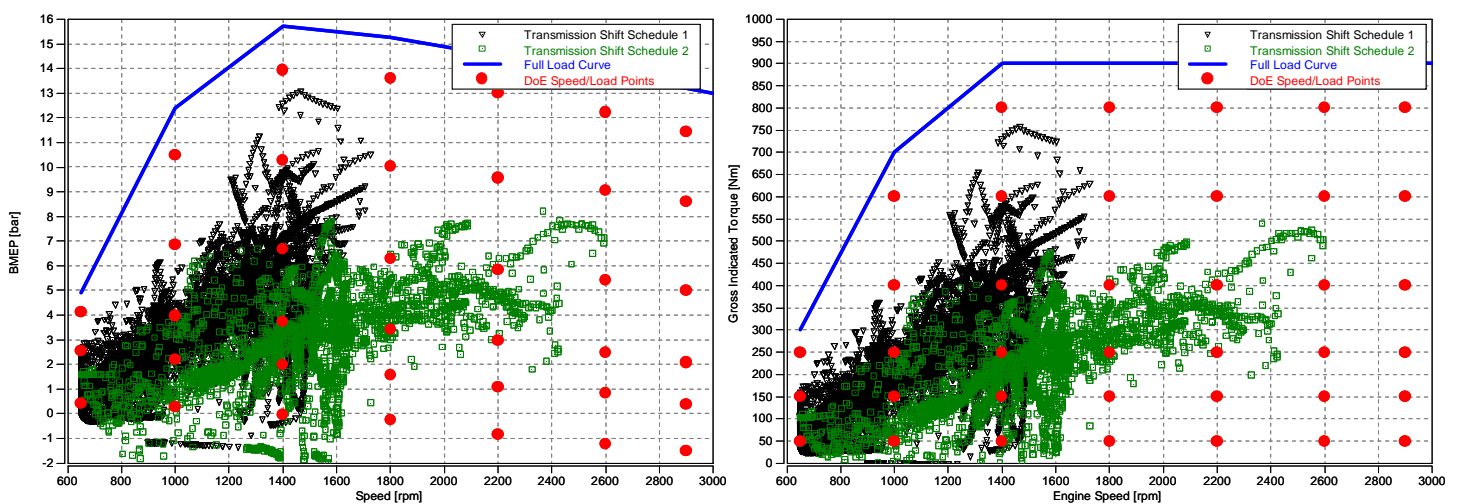

Figure 1. On the left, two different transmission shift schedules are used in a vehicle simulation that translates vehicle speed versus time to engine speed and load versus time. On the right, the drive cycle points have been mapped to gross indicated torque by interpolating an engine map. The regular grid of speed and gross indicated torque in the right graph is similarly mapped to brake torque by interpolating an engine map.

## SELECT DOE SPEED/LOAD OPERATING POINTS

In most engineering activities there are tradeoffs between time invested and measurement resolution realized. This is certainly true in designed experiments for calibration. Calibration tables that vary with speed and load may have 64, 100, 256, or even more individual cells to fill. Fortunately not all of these cells are of equal importance. The drive cycle cascade from the preceding section should give insight into which regions of the calibration space may need more refinement.

Of course, to avoid extrapolation, DoE points should also cover as much of the operating range as possible. Areas outside of the selected DoE points, but inside the engine operating envelope, will need to be calibrated manually or perhaps by a different type of designed experiment. The ability to calibrate near the outer envelope of the calibration space depends a great deal on the ability of the test cell automation system to respond quickly and appropriately to defined operating limits.

If testing time allows, covering every other row and column in a subset of the operating map is a good place to start. Table brake points should be slightly closer in regions of high importance on drive cycles and in regions of steep gradients in engine response. The regions of steep engine response can be found by examining engine maps from either competitive or prior generation engines.

## CALCULATE TIME WEIGHTS FOR EACH DOE POINT AND DRIVE CYCLE

During the optimization process, drive cycle results will be estimated by summing the products of the time weights and mass flows at each DoE point. Distributing the time spent at each operating point in the drive cycle to each of the DoE

points can be done in several ways. The simplest way is to imagine boxes or bins around each of the DoE points such that the entire map area is assigned. The time spent at each speed/load point from the drive cycle can be accumulated in the bins.

Although this simple binning method will sometimes give adequate results, it can also give very misleading results. The most common problem with binning occurs when a very highly weighted drive cycle point, such as idle, resides between two DoE points but is slightly closer to one than the other. With binning, all of the time spent at idle ends up on one bin even though the idle operating condition would be more accurately represented by something in between the two bins.

To address this quantization error, it is more reasonable to assign time to bins based on a distance-weighted average. For each speed/load point on the drive cycle, the nearest four DoE points can be found, and the time can be divided among these four points based on how far away the points are. Because the load and speed scales may not be the same order of magnitude, it is best to divide the load distances by the average load spacing and to divide the speed distances by the average speed spacing.

It is also important to make sure that energy is conserved during the binning process, so after the relative contributions of the nearest DoE points are determined, the total time can be adjusted to make sure that energy (proportional to the product of speed, load, and time) is conserved.

## **DOE FACTORS AND BOUNDS**

### **IDENTIFY CALIBRATION FACTORS**

Modern diesel engines have many degrees of freedom that are never entirely independent of one another. As a result, the models required to capture all of the interactions tend to be quite complicated. Even for a single pilot injection strategy, there are six basic input parameters. Four are related to injection (main timing, pilot timing, pilot quantity, and fuel rail pressure) and two are related to controlling the air path. Several options exist for air path control, but in general, the options are any two of the following: boost pressure, exhaust gas recirculation (EGR) rate, and fresh air mass. Of course, there are other ways to define the controller, but for steady-state operation, there is very little difference among the choices. Early in a calibration process, however, boost pressure coupled with fresh air mass control is probably the most straightforward to implement as both of these parameters can be measured directly with engine sensors.

The selection of control parameters used in the final calibration strategy is not particularly important at this point in the development process as long as the data needed to calculate the other control parameter is collected during the DoE runs. For instance, if the DoE is run using boost pressure and air mass control, but the real strategy will use oxygen percentage in the intake and exhaust as the basic input parameters, these can simply be measured during the DoE runs. When response models are built, either set of inputs can be used and the other set can be predicted by response models.

The most important consideration at this stage in development is stable operation requiring minimal pre-DoE calibration. The immature state of the overall engine calibration may be such that the DoEs must be run as functions of turbocharger vane position and EGR valve position. This is certainly acceptable but may make selecting limits a bit more challenging.

If direct control of actuators is the only feasible operating mode, and multiple, sequential actuators are utilized to affect the same control, it is beneficial to combine them in a logical way such that only one input is used. For instance, if both turbo vane position and a wastegate are used to control boost pressure, it is helpful to combine them into one scale such that for values below some threshold, the wastegate begins to open and the vanes remain wide open. Above this same threshold, the wastegate remains closed and the vanes begin to close. This combined input can be thought of as a boost system position control. Similar operation could be defined for the EGR valve and an intake throttle upstream of EGR introduction or for an EGR valve and a throttle valve downstream of EGR takeoff. This combined input could be called the air system position control.

### **SELECT RANGES FOR EACH PARAMETER AT EACH DOE POINT**

The intent with any DoE is to ensure that the optimum solution lies within the DoE bounds. The selection of input ranges depends a great deal on the intended use of the models, the similarity of the current experiments to prior experiments, and the time available for engine testing. If the mapping exercise is intended to be a small change compared with a prior calibration and little time is available, the range setting process will be largely based on experience. Small variations around the current calibration set points may be all that is required, and simpler models may be used to capture these small disturbances.

If, however, there is little experience with the current hardware or the targeted emissions standards, a bit more testing time will be required, and the bounds will need to be expanded. These wide-bound DoEs can also be useful for calibrating the engine for multiple emissions standards and various applications that might have very different usage profiles.

The first step in performing wideband DoEs is a screening experiment that will characterize the air path components. The screening experiment will find combustion and engine mechanical limits related to boost pressure and EGR flow. The screening experiment essentially characterizes the performance of the turbocharger, heat exchangers, and air flow passages. It is a subset of the larger DoE in that only the boost system position control and air path position control parameters are varied at each speed/load point. Injection parameters need to be set to safe values. For instance, main injection timing could be set to 3 degrees before top dead center (BTDC), with a pilot schedule of a 2 mg/injection, 15 degrees before the main injection. If a rail pressure schedule exists from a prior calibration, it may be acceptable. Otherwise, a rail pressure schedule that linearly increases with speed and load from the minimum at idle to the maximum at rated power should suffice.

The most important outcome of the screening DoE is finding the boundaries of engine operation. These boundaries when viewed in the multidimensional space of the input parameters are never really rectangular because the systems interact with each other. Therefore, the structure of the DoE must be set up to find these curved surfaces. If a traditional D-optimal DoE were used, many of the points would fail as these DoEs tend to focus on the rectangular borders of the calibration space. A Latin Hypercube Sampled (LHS) DoE form is much more appropriate as it distributes points evenly throughout the calibration space.

To use automated DoEs for limit finding, the test cell automation system must have very fast control of the engine actuators in order to identify and eliminate the condition violating the limit. If fast actuator control isn't available, manual boost system position control sweeps can be performed at various air system position control settings.

The data collected from these screening experiments can be imported into Model-Based Calibration Toolbox to build one-stage models that relate speed, load, boost position, and air system position to the mechanical limits, combustion limits, and the chosen calibration factors. Convex hull boundary models like those shown in Figure 2 should also be built. All of these models can be exported into CAGE to generate maximum and minimum values of the calibration factors at each DoE speed/load point. When defining combustion limits, the bounds should be set much wider than the intended calibration goals so that the models extend beyond the ideal range. For instance, one goal in the final calibration may be to keep smoke below 2 FSN. To ensure the models accurately predict the penalty of going beyond 2 FSN, the DoE data should extend to perhaps 4 FSN. Similar loose bounds can be applied to hydrocarbons and combustion stability but cannot be applied to engine mechanical limits.

Ranges for the injection timings and quantities can generally be varied over the same range for all DoE speed/load points, so complicated screening experiments are not required. Limits in rail pressure can be defined as variations of ~300 bar from either a baseline calibration or a schedule that is linearly varying with speed and load from near the minimum at idle to the maximum at rated power.

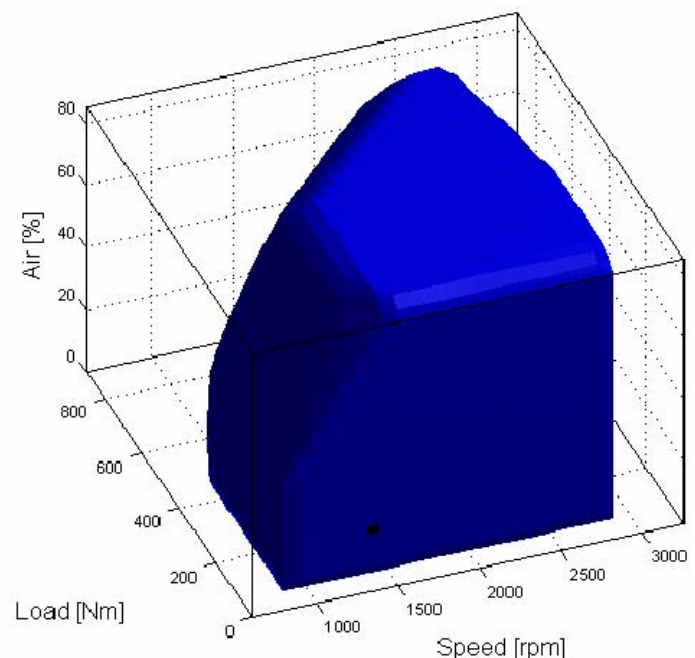
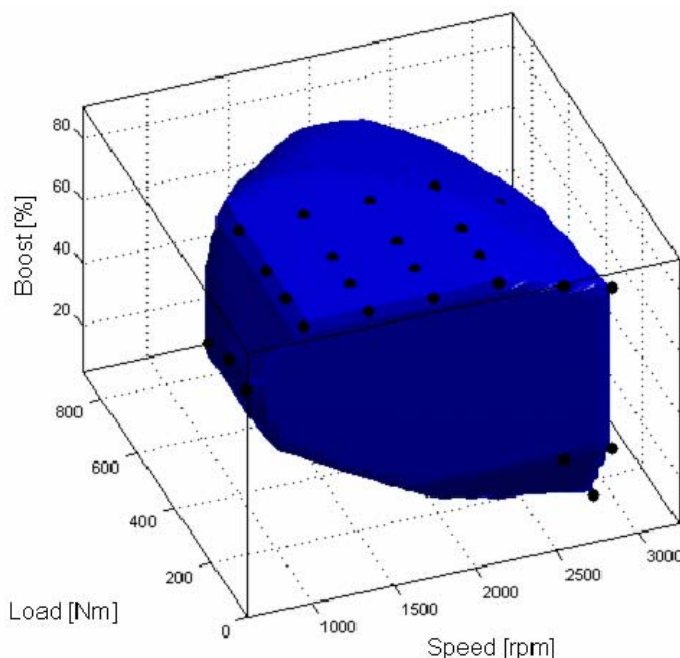

## SELECT DOE SIZE AND SHAPE

Using the preceding method to find DoE bounds does not guarantee that no points fail during DoE testing. In fact, several points are expected to fail at each speed/load point. If all of the points at a particular speed and load pass, it is likely that the entire calibration space has not been explored. For DoEs intended to refine an existing calibration this is acceptable. For wide-range DoEs, the boundary of the cluster of points that pass determines the acceptable operating range of the engine.

When building multiple DoE runs at several speed/load points, it may be beneficial to develop a generic DoE template. The template can have each of the six factors mapped from 0 to 1. The generic DoE can then be scaled to match the bounds from the previous step at each speed/load. The generic DoE needs to contain enough points to build the response models. As an example, if one wanted to build third-order models with third-order interactions, there are 84 degrees of freedom. The proposed, generic experiment should be evaluated in Model-Based Calibration Toolbox. For the 84 degree of freedom model, 190 Halton sequence runs were required to keep standard error (for coefficients) and hat matrix leverage values within acceptable bounds. Because some of the points are expected to fail, the number of test runs at each speed/load should be at least 125% of this minimum. If more than 20% of the test points fail, then the DoE should be augmented with more points. Fortunately, after running the first DoE, detailed boundary models can be used to determine where more points can be added safely. There should be a significantly higher success rate with the augmented points.

## COLLECT DATA AND PREPARE FOR MODEL-BASED CALIBRATION TOOLBOX

The runs for each speed and load point can be combined into one test schedule and randomized to prevent uncontrolled factors from skewing the data. One example of an uncontrolled factor is the cleanliness of the EGR cooler. EGR coolers tend to collect soot at an accelerated rate during DoE testing. This accelerated fouling is generally due to the extremes in combustion that are explored. High hydrocarbons at one point followed by high soot at the next are very likely to result in soot fouling of the gas-side, heat-transfer surfaces.

If a specific uncontrolled, but measurable noise factor is found to be adversely skewing data, more points can be added, and the effect of the noise can be modeled. For example, the EGR cooler cleanliness could be estimated by comparing a model of heat exchanger performance with the actual heat transfer.

The test schedule should be broken into manageable pieces that run for only several hours at a time. In between each batch of testing, a few points should be repeated to verify that something hasn't significantly shifted in the engine. For example, if a leak occurs, careful inspection of the rig stability check points can help find the issue and prevent more questionable data from being acquired. Rerunning common points will also help identify deteriorating performance of the EGR cooler. Periodic cooler cleaning could be triggered by monitoring the cooler performance at one of the rig stability check points.

After all of the data have been recorded, they can be collected into a common file for import into Model-Based Calibration Toolbox. Additional calculations can also be added to the data set if they are needed, but were not available in real time during testing. Obviously, the details of this process step depend on the specific test systems being used.

## BUILD MODEL-BASED CALIBRATION TOOLBOX MULTIMODELS AND BOUNDARY MODELS

To build multimodels in Model-Based Calibration Toolbox, a two-stage model must have precisely two inputs at the global level. The two global inputs are used to switch between the detailed local models that relate the local inputs to the engine responses. The resulting models have independent boundary models at each speed and load point as well.

To actually build the multimodels, first a conventional two-stage test plan must be set up. Speed and load are used for the two global inputs. The same choice of local inputs is available here as in earlier steps. The local inputs can be either the actual parameters controlled during the DoE testing or those planned to be used in the production control strategy as long as these inputs were measured or calculated from measured data. Figure 3 is an example of a properly developed multimodel test plan.

Model-Based Calibration Toolbox has the ability to select the best matching model type as well. If enough data exists, third-order polynomials with third-order interactions often fit well. Radial basis functions may also be selected. One

advantage of using multiple models as the local model selection is that Model-Based Calibration Toolbox can perform the Minimize PRESS model simplification routine to polynomial models automatically. This is a great time-saving feature.

It may be helpful to look at the distribution of data for several pairs of parameters in the Data Editor in preparation for selecting boundary model types. Unfortunately, the multimodel graphical user interface (GUI) does not support viewing multimodel boundary models in R2008a (Model-Base Calibration Toolbox 3.4). This feature is under development for a

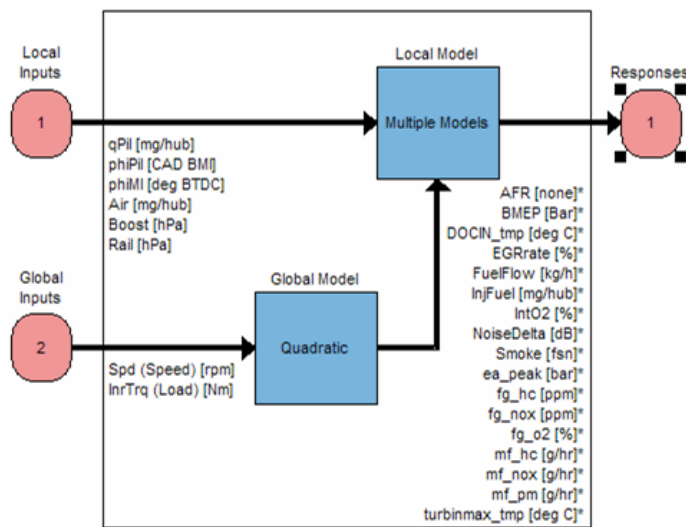

Figure 3. After data has been imported into Model-Based Calibration Toolbox, models can be built for each of the responses that relate to limits, optimization objectives, or alternate calibration inputs.

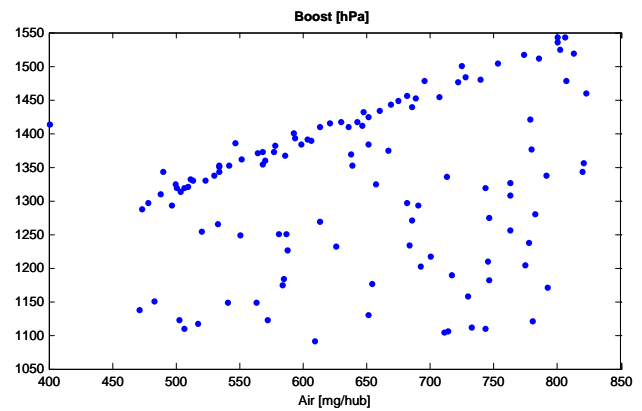

Figure 4. In this experiment, requested boost pressure was used as an input, but due to interactions with the requested air mass, many of the points had unachievable boost pressure set points. This results in the cluster of points near the upper bound of this two dimensional calibration space. If vane position had been controlled instead, the data would have likely been better distributed.

future release. To fully evaluate the boundary models before exporting to CAGE, each speed/load point would need to be built as a one-stage test plan so that the one-stage boundary model tools could be utilized. The combination of building one speed/load point as a one-stage test plan and examining the distribution of input parameter pairs in the Data Editor should be sufficient to determine appropriate boundary model types.

Figure 4 shows the distribution of test data at one speed/load point versus desired air mass and desired boost pressure. This distribution looks as though a convex hull boundary model would fit the data nicely. Whenever possible, range constraints will improve the robustness of the boundary model fitting routines. Simply requesting convex hull boundary models as a function of all six parameters can yield unexpected results. Unfortunately, until the multimodel boundary model GUI is available, verifying the quality of boundary models is neither straightforward nor efficient.

The greatest efficiency advances in R2008a versus R2007b in relation to multimodels are found in the next step. The interface with CAGE is significantly improved. To build the boundary models and export the multimodels to CAGE, simply open a new CAGE session, select the test plan to be exported in the Model Browser, and choose the Test Plan... Export Multimodels menu item.

From this GUI, appropriate boundary models can be set up. A simple range constraint on every parameter plus a convex hull constraint on main timing, air mass, boost pressure, and rail pressure make fairly robust boundary models. If other interactions are also considered to be critical, they could either be added into the convex hull boundary model, or another convex hull boundary could be added. For instance, if the interaction between pilot timing, pilot quantity, and main timing is

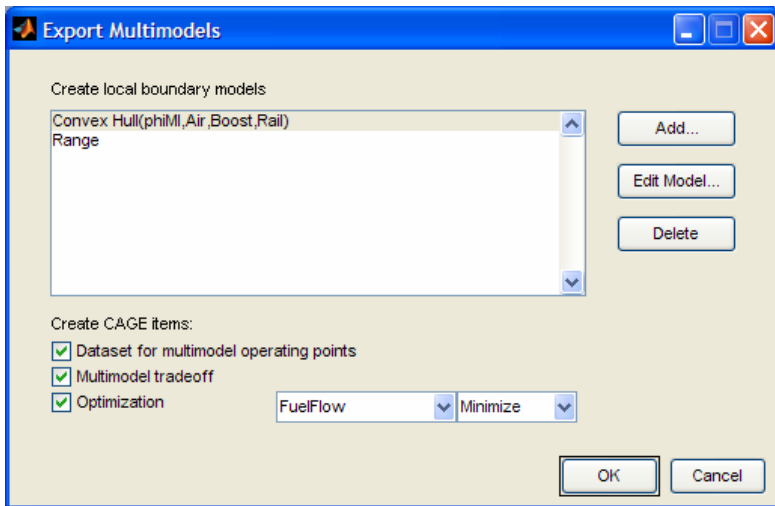

Figure 5. The Export Multimodels GUI in R2008a offers a large improvement in usability over prior releases.

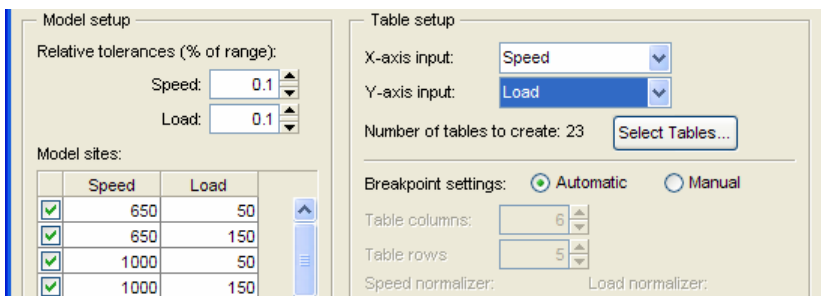

Figure 6. The Export Multimodel script can generate a CAGE tradeoff. By default it will set up tables for each input and each response with enough rows and columns to accommodate the DoE speed/load points. It is also possible to ask for larger tables that represent the actual calibration tables in the control strategy. Filling these tables from an optimization output and exporting to ETAS INCA or ATI Vision is then very direct.

deemed critical to combustion stability, then a second convex hull boundary model could be included. Experimentation with a one-stage test plan is the only way to be certain that the boundary models will yield the desired results.

The three check boxes at the bottom of the form offer new functionality. The script behind the new form will create a data set in CAGE that contains the speed and load set points as well as the middle of the range of each input. This makes a very useful starting point for optimizations. Of course, the script also sets up an optimization for the selected response complete with a boundary model. A simple, point-by-point optimization to minimize fuel consumption is a good place to start.

The Multimodel tradeoff check box asks the script to generate a manual tradeoff. This option opens another dialog box that is partially shown in Figure 6. From this form, the speed and load brake points can be specified to match those in the production calibration. By default, tables of every input and response are built. As a result, if the production calibration actually uses one of the response models as the control input, the appropriate calibration table can easily be exported directly to ETAS INCA or ATI Vision.

## OPTIMIZE CALIBRATION

### POINT-BY-POINT OPTIMIZATION

The first step in the optimization process is to find a set of independent solutions that satisfy the basic limits and minimize fuel consumption. There are two basic uses for this solution. First, this solution is a reasonable starting point for the cycle optimized solution. Second, for speed/load points with very little weight on any of the drive cycles, a calibration that minimizes fuel consumption is probably the best goal. Figure 7 shows how the objectives and constraints should look for the locally optimized solution. The multimodel export script has already configured one run for each speed/load, set the free variables to midrange values, and entered the fixed variables (speed and load) for each run.



## CYCLE OPTIMIZATION

Converting the independent optimization to a cycle-optimized calibration involves a few simple steps. First, the independent optimization should be duplicated, and the starting point of the new optimization should be filled with the output of the independent solution. Next, the fuel flow point objective should be converted to a sum objective with the

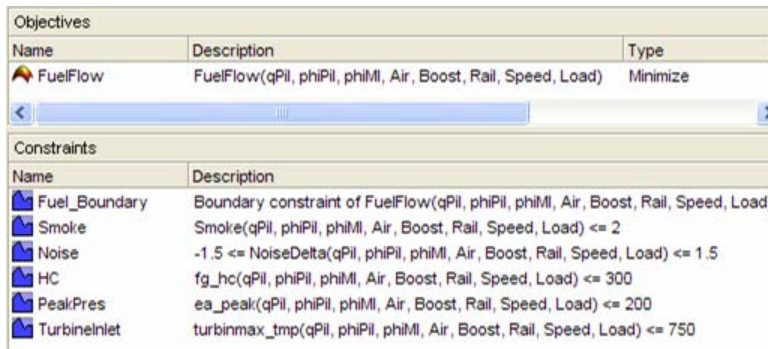

Objectives		
Name	Description	Type
FuelFlow	FuelFlow(qPil, phiPil, phiMI, Air, Boost, Rail, Speed, Load)	Minimize

Constraints	
Name	Description
Fuel_Boundary	Boundary constraint of FuelFlow(qPil, phiPil, phiMI, Air, Boost, Rail, Speed, Load)
Smoke	Smoke(qPil, phiPil, phiMI, Air, Boost, Rail, Speed, Load) <= 2
Noise	-1.5 <= NoiseDelta(qPil, phiPil, phiMI, Air, Boost, Rail, Speed, Load) <= 1.5
HC	fg_hc(qPil, phiPil, phiMI, Air, Boost, Rail, Speed, Load) <= 300
PeakPres	ea_peak(qPil, phiPil, phiMI, Air, Boost, Rail, Speed, Load) <= 200
TurbineInlet	turbinmax_tmp(qPil, phiPil, phiMI, Air, Boost, Rail, Speed, Load) <= 750

Figure 7. The first step in optimization is to locally optimize each speed and load for minimum fuel consumption while respecting the boundary models, mechanical limits, and indicators of poor combustion.

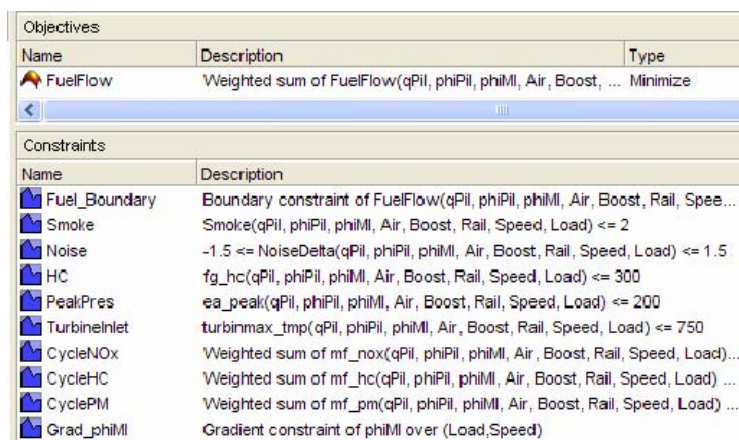

Objectives		
Name	Description	Type
FuelFlow	Weighted sum of FuelFlow(qPil, phiPil, phiMI, Air, Boost, ...)	Minimize

Constraints	
Name	Description
Fuel_Boundary	Boundary constraint of FuelFlow(qPil, phiPil, phiMI, Air, Boost, Rail, Spee...
Smoke	Smoke(qPil, phiPil, phiMI, Air, Boost, Rail, Speed, Load) <= 2
Noise	-1.5 <= NoiseDelta(qPil, phiPil, phiMI, Air, Boost, Rail, Speed, Load) <= 1.5
HC	fg_hc(qPil, phiPil, phiMI, Air, Boost, Rail, Speed, Load) <= 300
PeakPres	ea_peak(qPil, phiPil, phiMI, Air, Boost, Rail, Speed, Load) <= 200
TurbineInlet	turbinmax_tmp(qPil, phiPil, phiMI, Air, Boost, Rail, Speed, Load) <= 750
CycleNOx	Weighted sum of mf_nox(qPil, phiPil, phiMI, Air, Boost, Rail, Speed, Load)...
CycleHC	Weighted sum of mf_hc(qPil, phiPil, phiMI, Air, Boost, Rail, Speed, Load) ...
CyclePM	Weighted sum of mf_pm(qPil, phiPil, phiMI, Air, Boost, Rail, Speed, Load) ...
Grad_phiMI	Gradient constraint of phiMI over (Load,Speed)

Figure 8. A cycle-based optimization can include drive-cycle emissions constraints and table gradient constraints in addition to all of the point constraints.

appropriate time weights. Third, new sum constraints should be added for each of the important emissions mass flows, again, with the appropriate time weights. If multiple drive cycles or multiple vehicle combinations need to be considered, sum constraints for each of the emissions on each of the drive cycles can be added. Unfortunately, for single objective optimizations, additional fuel flow objectives cannot be added. However, the time weights for the multiple cycles can be added together. If one drive cycle is more important than another, then appropriate weights can be applied to the time weights. Of course, if multiple time weights are combined with their own weighting factors, the cycle total no longer represents anything real. Clearly the objective is still to minimize fuel consumption, so the results will be directionally correct. If need be, a sum constraint for fuel consumption can also be added if there is a cycle-based target for one of the drive cycles.

The results of the cycle-based optimization depend on the definition of the drive cycle. When working in gross indicated torque, the relationship between brake torque and gross indicated torque depends on the calibration. After the first iteration of optimization, the drive cycle should be remapped from brake to gross indicated torque and the optimization should be repeated. This process can be repeated until the results converge. Some example results are shown in Figure 9.

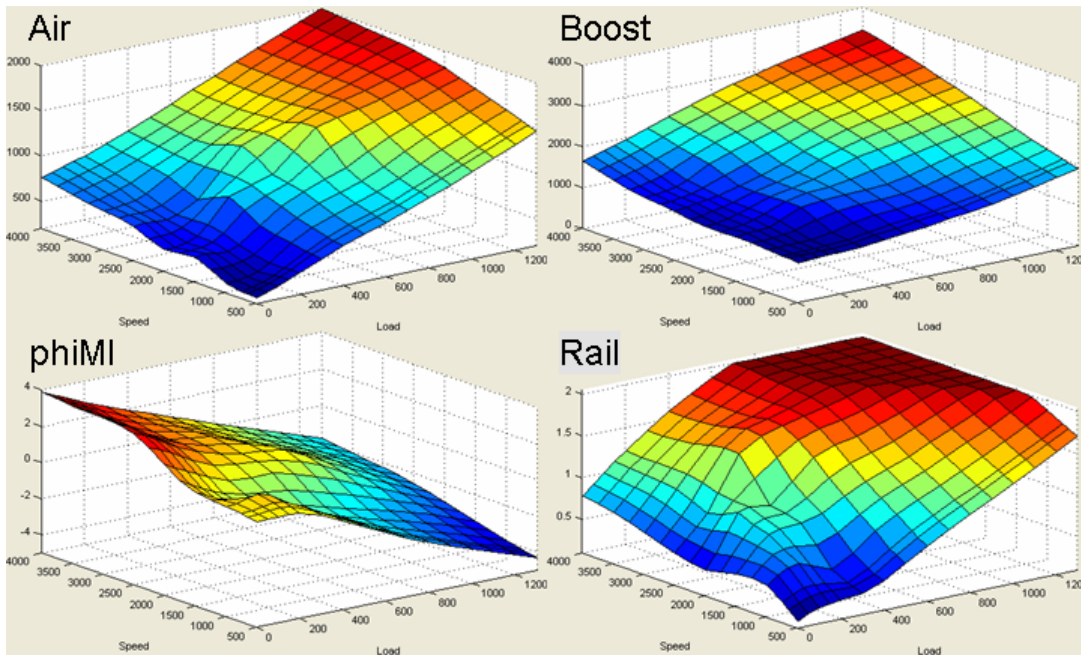

Figure 9. The calibration produced by the CAGE optimization process yields relatively smooth results. The results can be exported directly to ETAS INCA or ATI Vision. Engine operation in the extrapolated region should be carefully verified.

## EXPORT CALIBRATION AND VERIFY RESULTS

To export the calibration to ETAS INCA or ATI Vision as one collected file, the names of the tables must match the names of the variables in the strategy. Copies of the tables can be renamed appropriately, and then all of the tables can be exported together. It is acceptable if there are additional tables in the exported file, because they will be ignored by the import tool. It is also possible to copy and paste each table from CAGE to the target maps. A third approach is to export the tables in CAGE and then manually rename the important tables in the resultant Vision or DCM file.

If the experiments were performed with brake torque as the load axis, the tables will need to be interpolated to the load axis used in the control strategy.

The engine should be mapped in fine increments to verify that there are no unexpected results anywhere in the map. The full load curve can be extracted from the maps at the targeted brake torque levels; however, this is a region that is extrapolated. Great care should be exercised when evaluating this extrapolation. Either the full load curve can be calibrated manually, or another automated process can be used specifically to define the full load calibration.

## CONCLUSION

A complete process to develop a steady-state, base engine calibration at fully warm conditions had been described. The new features in Model-Based Calibration Toolbox 3.4 in R2008a have been highlighted. These new features offer large improvements in usability over previous implementations of multimodels.

Where choices need to be made in the calibration process, recommendations have been made based on the intended application. For instance, dynamometer-certified products should be calibrated in brake torque, and chassis-certified products should be calibrated in gross indicated torque. In either case, map interpolation is used to translate from one axis to the other, but at different steps in the process.

## ACKNOWLEDGMENTS

Clearly, a mapping exercise requires the support of many people. Special thanks need to be extended to those calibrators who delivered the basic feature calibration. These are Brian Hallgren, Alex Wenzel, Brent Keppy, Lawrence Vaduva, Joe Acar, and Ryan Johnson on one program and Brian Baldwin, Bryan Van der Velde, and Gus Johnson on another.

Special thanks are also extended to those responsible for automating the test cell and keeping it running. Rick Smith and Tom Beard developed the automation tools used to supervise all of the testing and assimilate data from each individual

measurement system. John Hancock and Tim Gardner were instrumental in the day-to-day operations of the test cell systems.

I'd also like to acknowledge Peter Maloney at The MathWorks for facilitating communication between the Model-Based Calibration Toolbox developers and me.

## **CONTACT**

Joshua P. Styron, Ph.D., Ford Motor Company, [jstyron@ford.com](mailto:jstyron@ford.com)