

Virtual Design of Electrified Powertrain Systems

Calibrating PMSM Torque Control Lookup Tables Using Model-Based Calibration

MathWorks Automotive Conference

Plymouth, MI

April 30th, 2019

Dakai Hu, Ph.D

-- MathWorks Application Engineering

Javier Gazzarri, Ph.D

-- MathWorks Application Engineering

PMSM Calibration

Productive

Automated

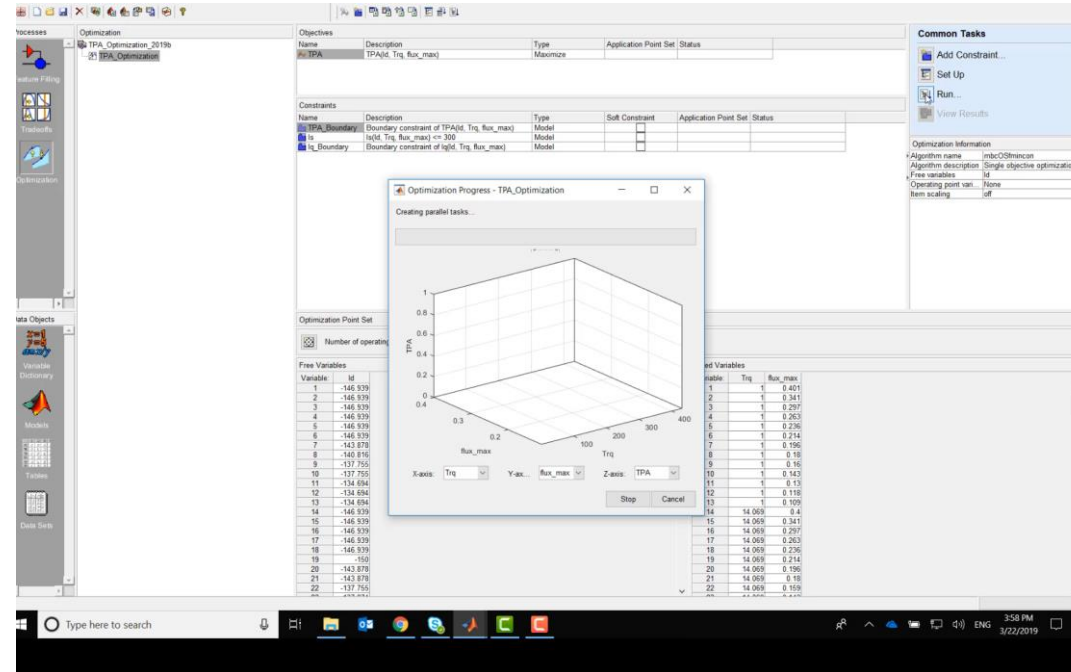

Scalable

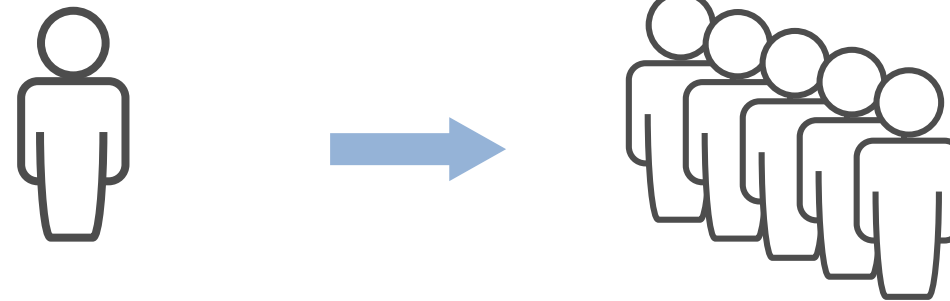

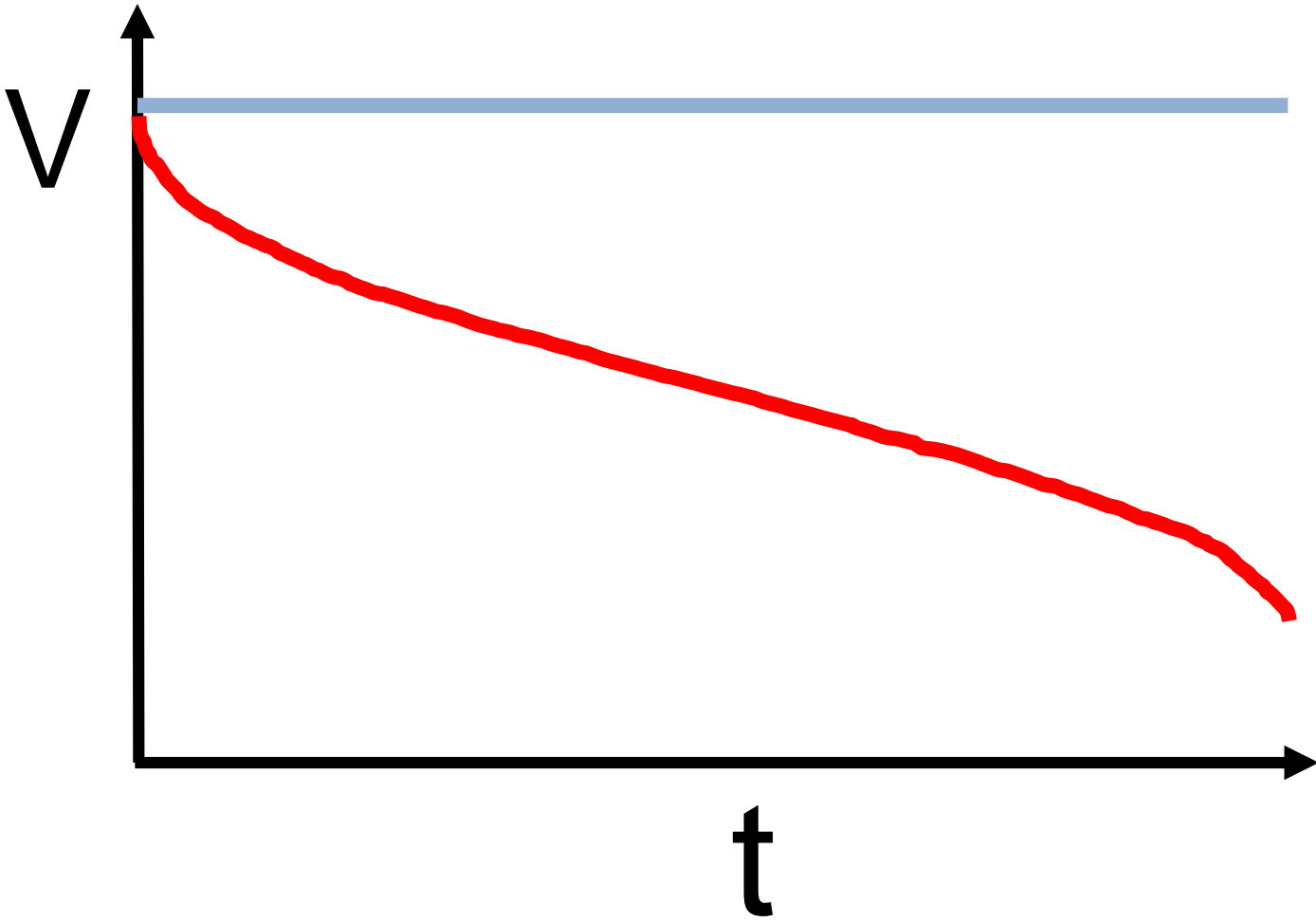

Effect of Inverter Bus Voltage Drop on Torque Control

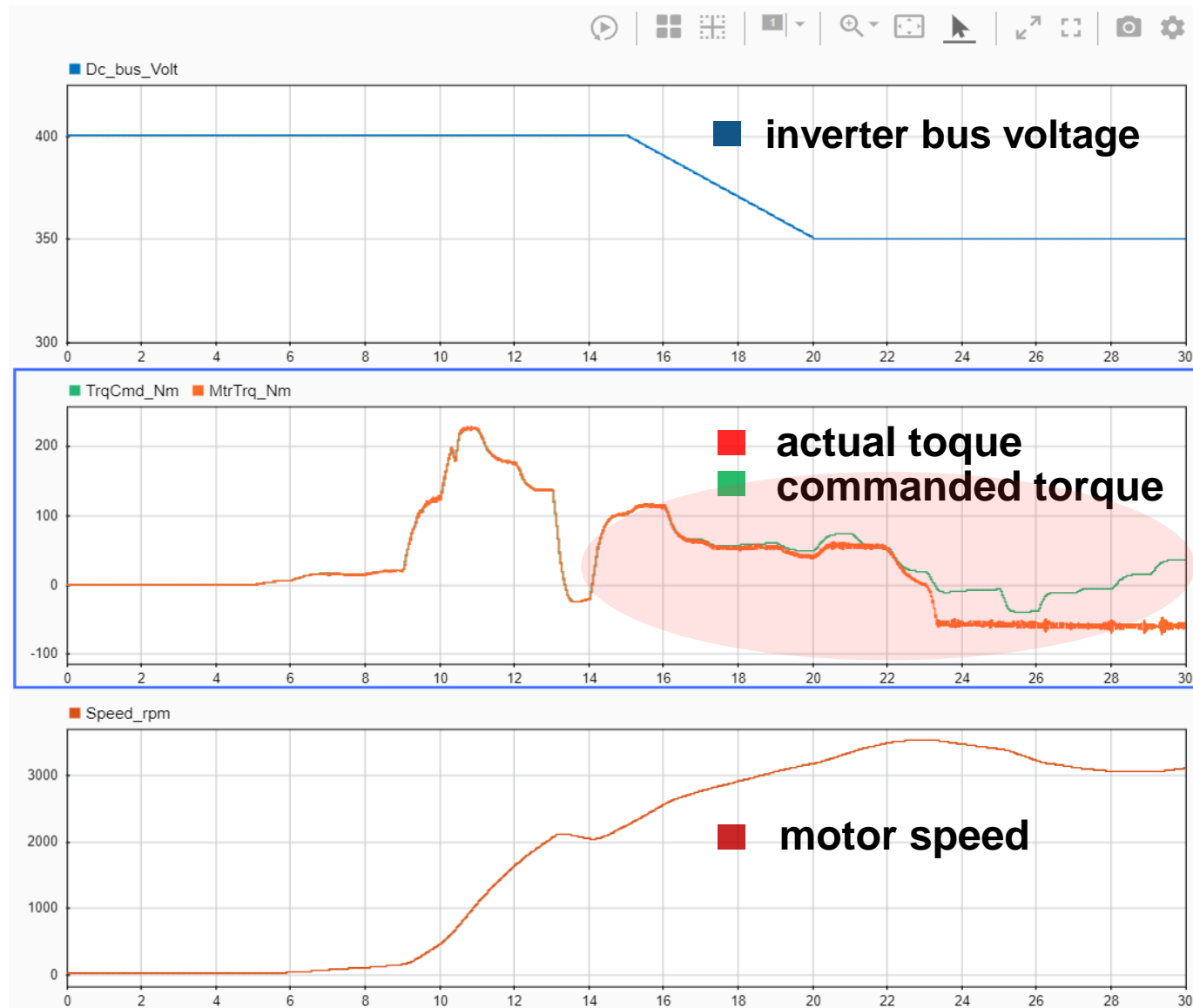

Flux-Based Calibration Tables

- Flux levels are adjusted based on variation of inverter bus voltage
- Key enabler: flux-based i_d and i_q tables

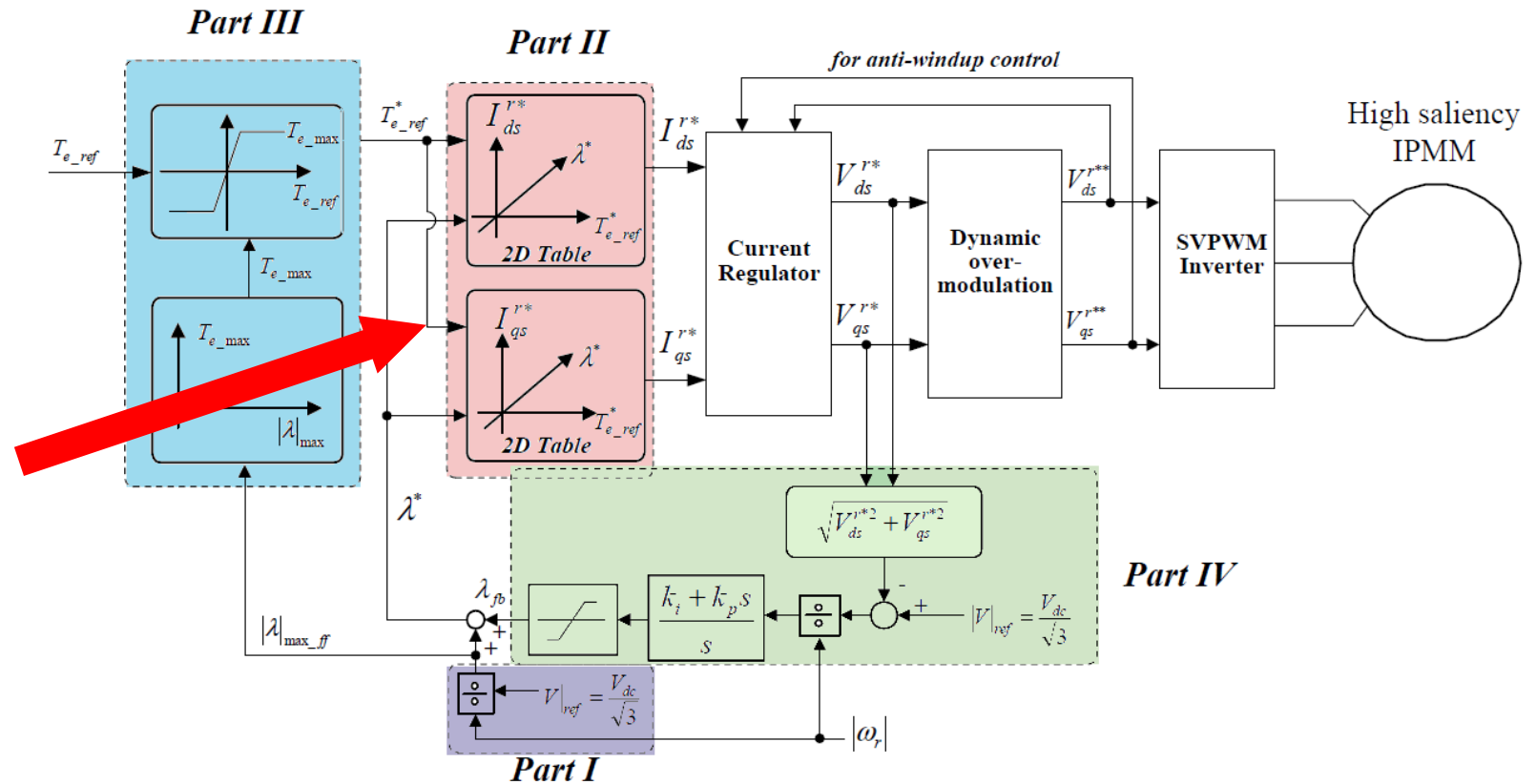

Simulink Implementation of Flux-Based Calibration Tables

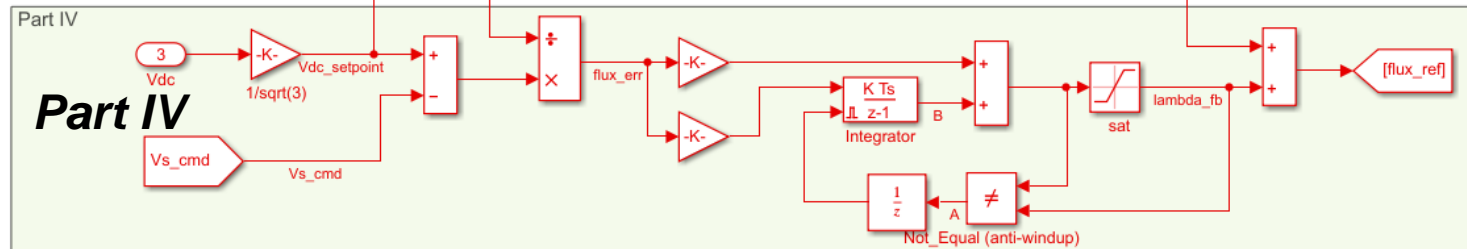
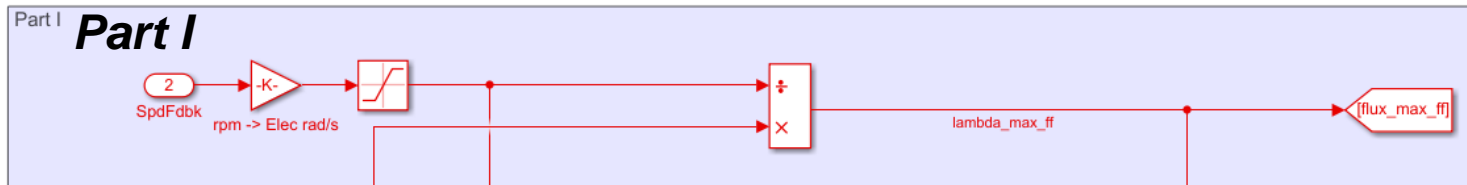
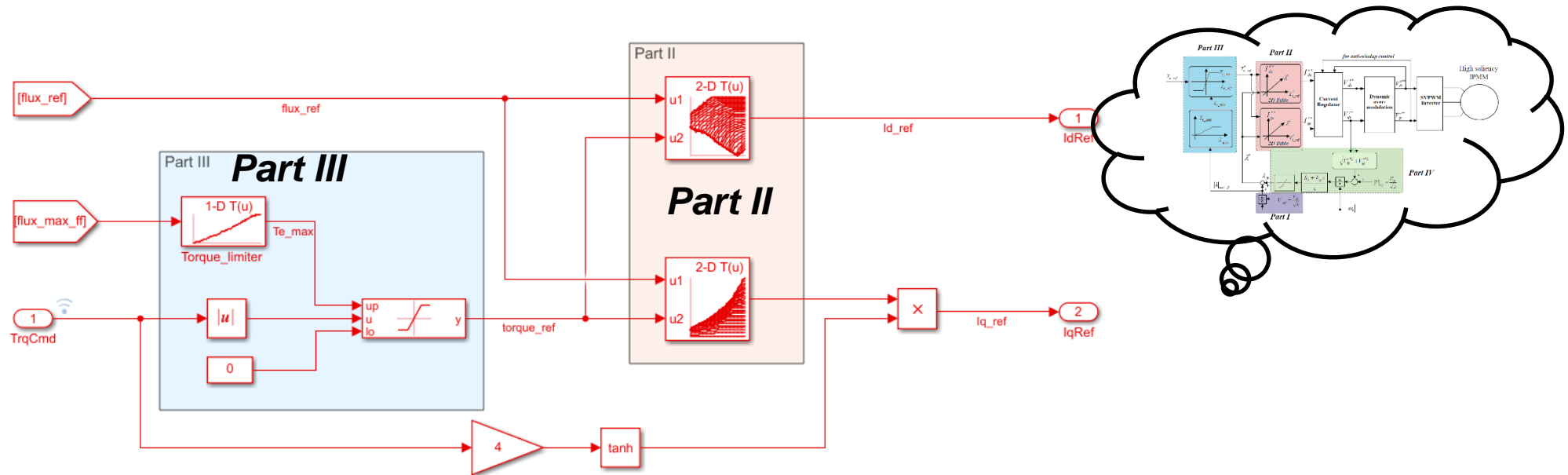

Flux-Based Calibration Tables – Simulation Results

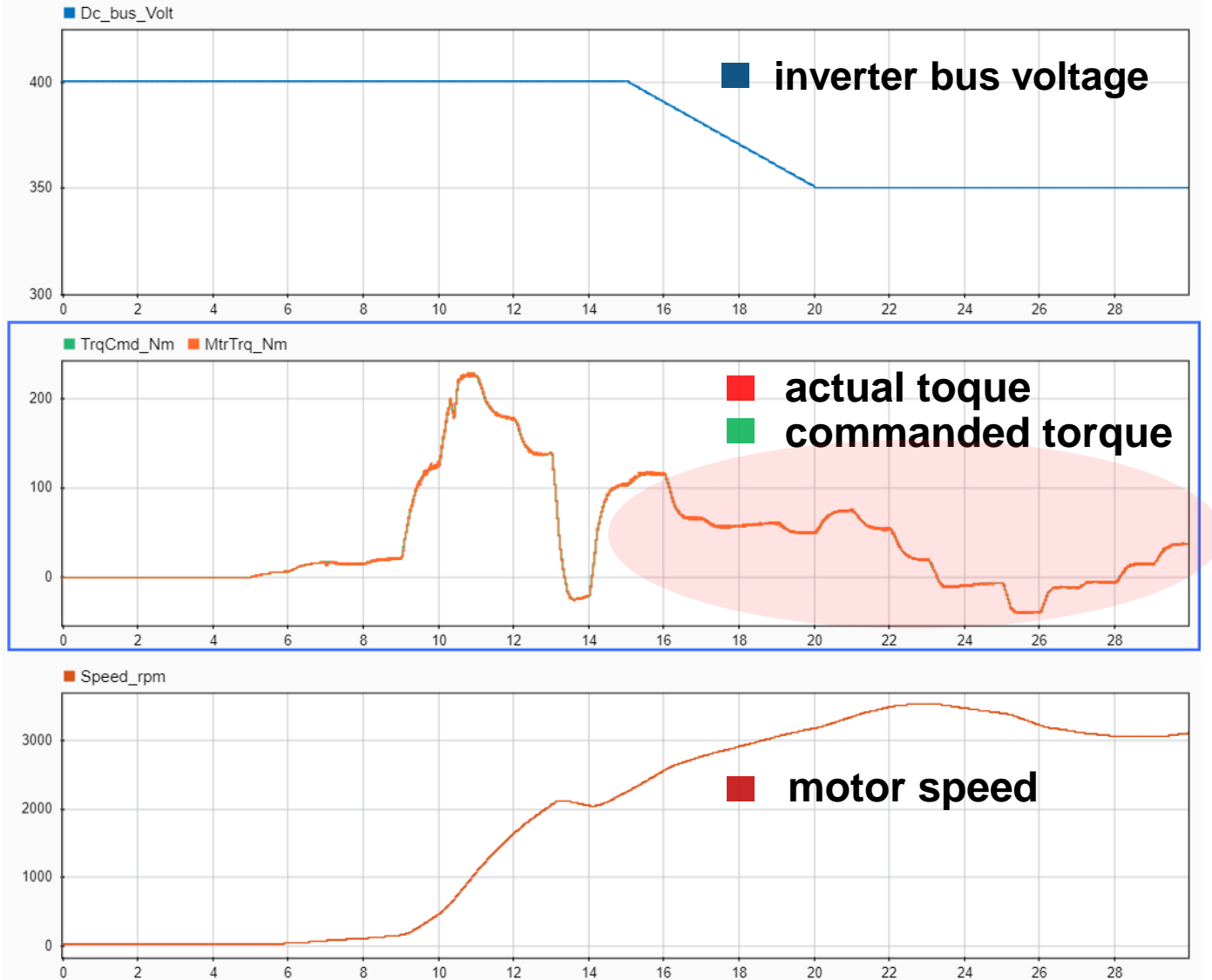

Flux-Based Calibration Tables

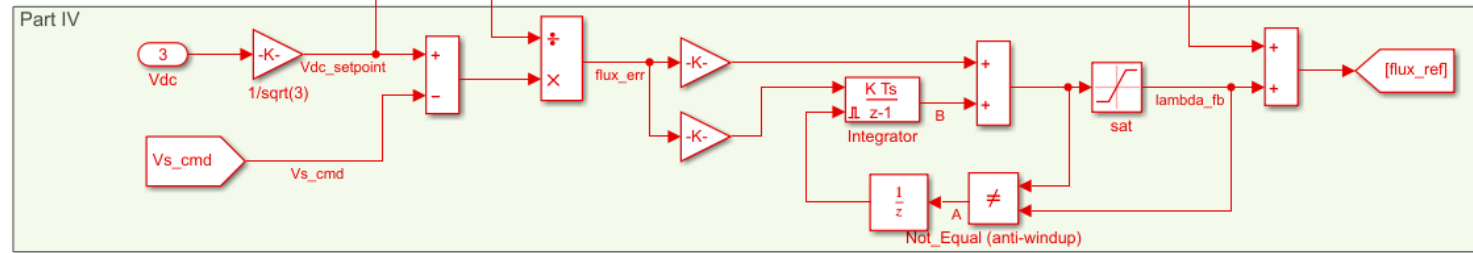
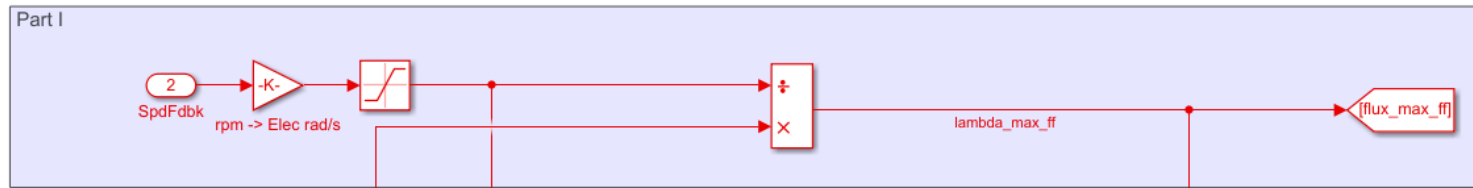
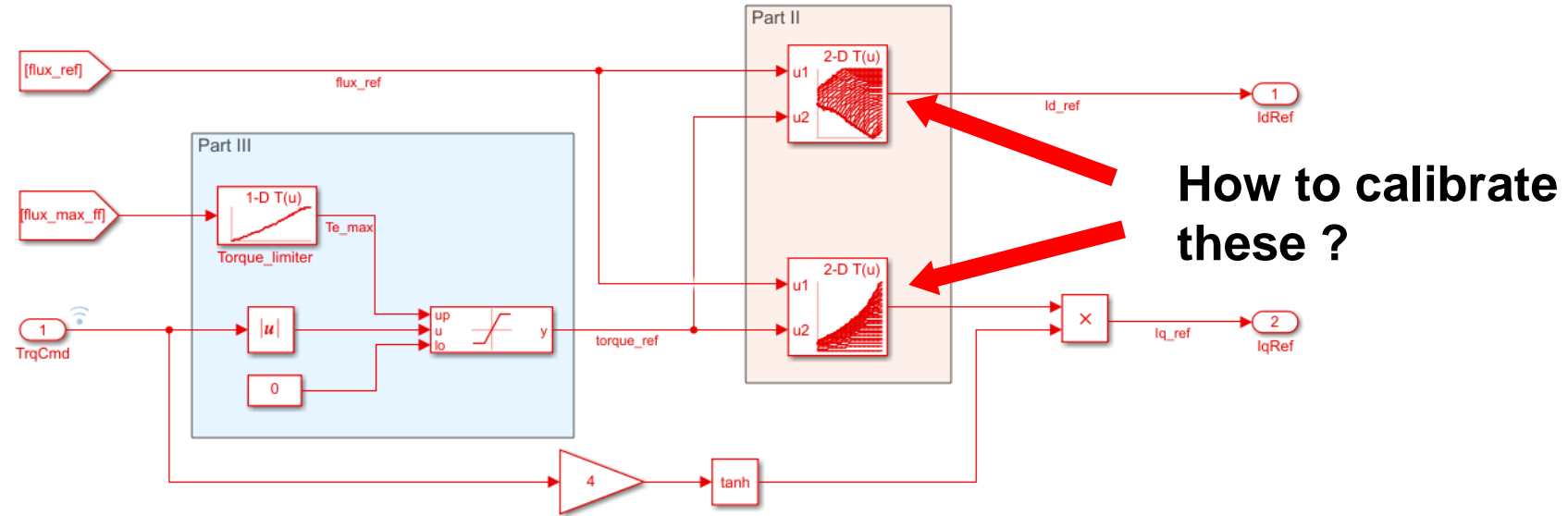

Different Ways to Calibrate Flux-Based Tables

Manual & Rule-Based Calibration

Model-Based Calibration

Manual

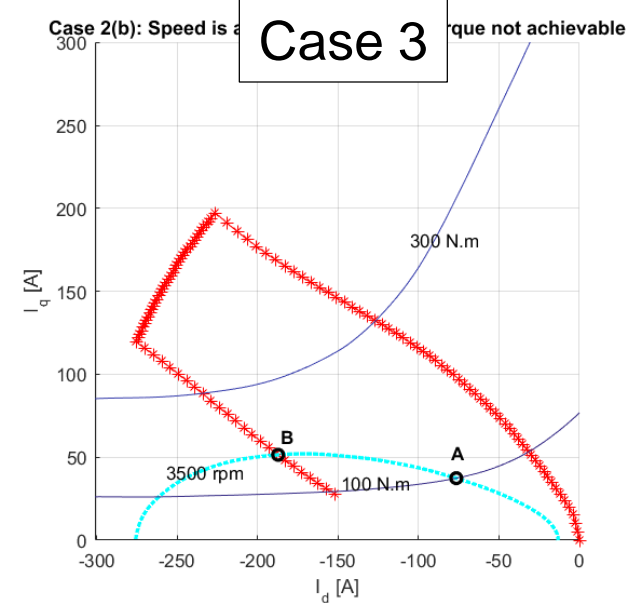
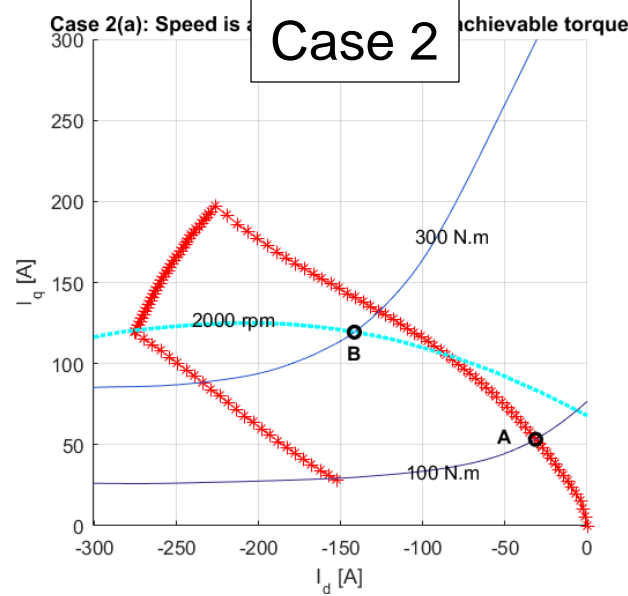
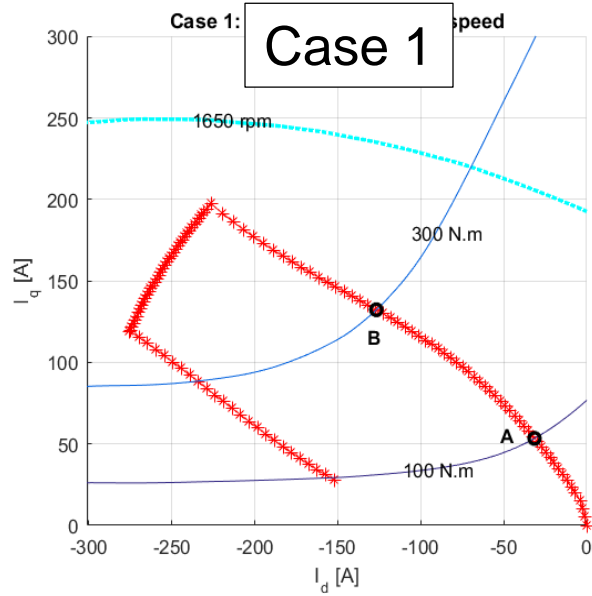
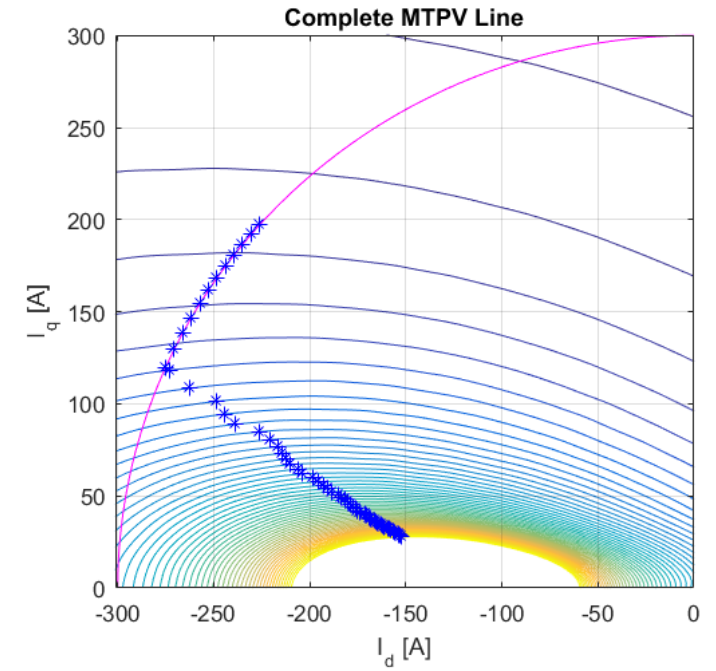
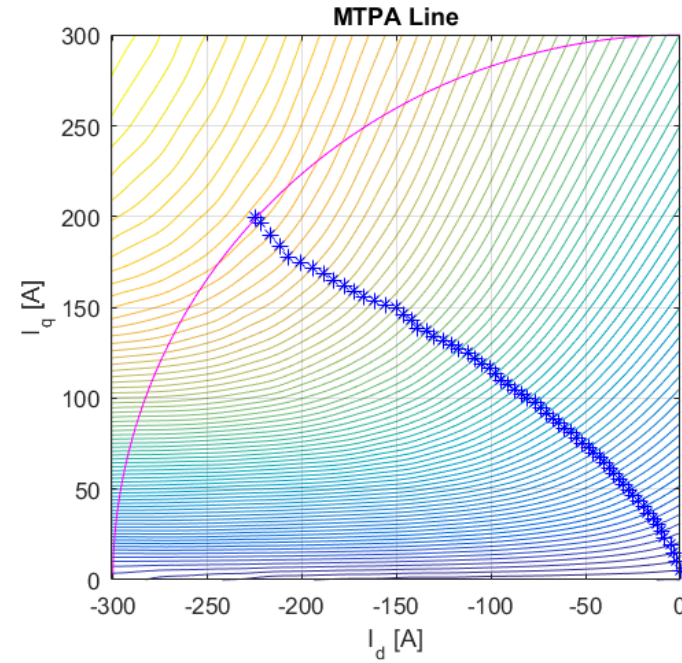

Model-Based Calibration

What is Model-Based Calibration (MBC)?

- Workflow for calibrating parameters for plant models and control systems
- Includes steps for
 - Design of Experiments (DoE)
 - Model fitting and optimization
 - Design parameter tradeoff studies
 - Calibration generation for lookup tables

Model-Based Calibration Workflow → MBC Toolbox

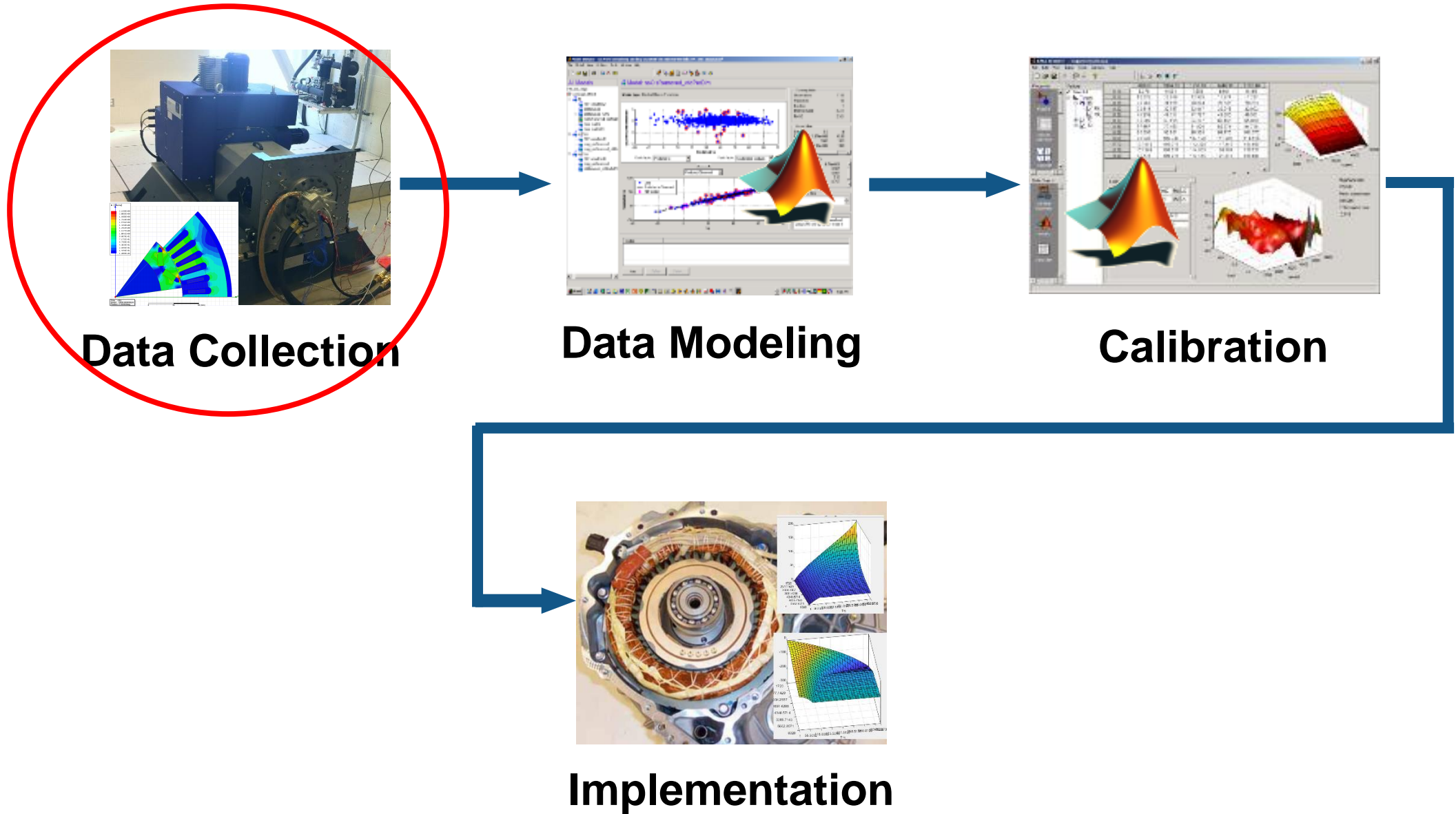

Data Collection (PMSM Characterization)

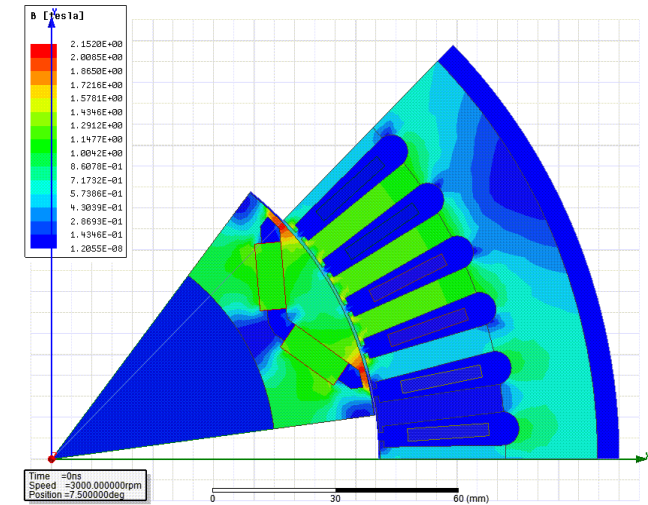
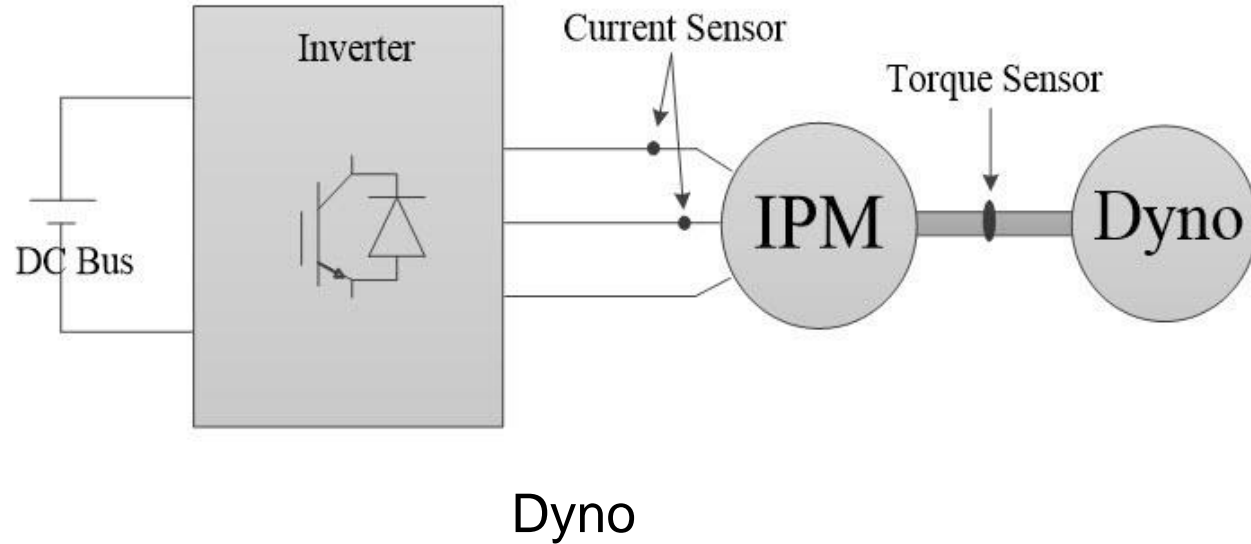

FEA

Reference: D. Hu, "Designing a Torque Controller for a PMSM through Simulation on a Virtual Dynamometer", MathWorks technical article.

<https://www.mathworks.com/company/newsletters/articles/designing-a-torque-controller-for-a-pmsm-through-simulation-on-a-virtual-dynamometer.html>

Data Collection (PMSM Characterization)

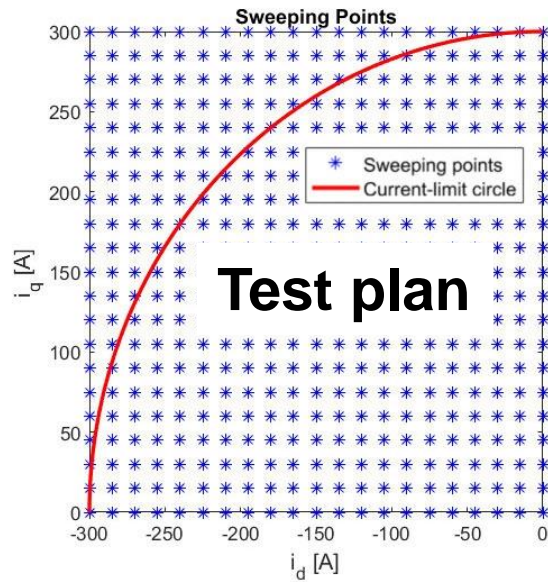

Logged data

Trq	Id	Iq	n	flux_d	flux_q	flux	flux_max	Is
1	-300	0.280117	1720	-0.22607	0.000767	0.226067	0.400577	300.0001
1	-293.878	0.278718	1720	-0.21943	0.000775	0.21943	0.40058	293.8777
1	-287.755	0.277608	1720	-0.21266	0.000784	0.212658	0.400584	287.7552
1	-281.633	0.27678	1720	-0.20575	0.000794	0.205752	0.400587	281.6328
1	-275.51	0.276228	1720	-0.19871	0.000804	0.198711	0.400591	275.5103
1	-269.388	0.275945	1720	-0.19153	0.000815	0.191535	0.400594	269.3879
1	-263.265	0.276042	1720	-0.18419	0.000826	0.184192	0.400597	263.2655
1	-257.143	0.276472	1720	-0.17669	0.000838	0.176691	0.4006	257.143
1	-251.02	0.277076	1720	-0.16907	0.00085	0.169076	0.400603	251.0206
1	-244.898	0.277709	1720	-0.16139	0.000863	0.16139	0.400606	244.8981
1	-	-	-	-	-	-	-	-
1	-202.041	0.28231	1720	-0.10615	0.000973	0.10615	0.400624	202.041
1	-195.918	0.283215	1720	-0.09798	0.000992	0.097986	0.400627	195.9186
1	-189.796	0.284261	1720	-0.08973	0.001012	0.089736	0.400629	189.7961
1	-183.673	0.285486	1720	-0.08138	0.001034	0.081385	0.400631	183.6737
1	-177.551	0.286922	1720	-0.07291	0.001056	0.072922	0.400633	177.5513
1	-171.429	0.288548	1720	-0.06438	0.00108	0.064389	0.400635	171.4288
1	-165.306	0.290404	1720	-0.05575	0.001106	0.055765	0.400637	165.3064
1	-159.184	0.292545	1720	-0.047	0.001133	0.047009	0.400639	159.1839
1	-153.061	0.295019	1720	-0.03807	0.001162	0.038084	0.400641	153.0615
1	-146.939	0.297869	1720	-0.02893	0.001192	0.028954	0.400643	146.9391
1	-140.816	0.301108	1720	-0.01959	0.001225	0.019632	0.400644	140.8166
1	-134.694	0.304738	1720	-0.01009	0.00126	0.010167	0.400646	134.6947



Data Editor - Point-by-Point : NewTestMBCData [Read Only]

File View Tools Window Help

Test Selector

Test	Flux...
1	0.401
2	0.341
3	0.297
4	0.263
5	0.236
6	0.214
7	0.196
8	0.18
9	0.16
10	0.143
11	0.13
12	0.118
13	0.109
14	0.401
15	0.341
16	0.297
17	0.263
18	0.236
19	0.214
20	0.196
21	0.18
22	0.16
23	0.143
24	0.13
25	0.118
26	0.109
27	0.401
28	0.341
29	0.297
30	0.263
31	0.236
32	0.214
33	0.196
34	0.18
35	0.16
36	0.143
37	0.13
38	0.118
39	0.109
40	0.401
41	0.341
42	0.297
43	0.263
44	0.236
45	0.214
46	0.196
47	0.18

Summary Statistics Variables Filters (2) Test Filters Test Notes

7621 / 30472 records
9 + 0 variables
214 / 214 tests

3D Data Plot

Data Table

	Flux	Flux a...	F
1	0.219	0.401	
	0.213	0.401	
	0.206	0.401	
	0.199	0.401	
	0.192	0.401	
	0.184	0.401	
	0.177	0.401	
	0.169	0.401	
	0.161	0.401	
	0.154	0.401	
	0.146	0.401	
	0.138	0.401	
	0.13	0.401	
	0.122	0.401	
	0.114	0.401	
	0.106	0.401	
	0.098	0.401	
	0.09	0.401	
	0.081	0.401	
	0.073	0.401	
	0.064	0.401	
	0.056	0.401	
	0.047	0.401	
	0.038	0.401	
	0.029	0.401	
	0.02	0.401	
	0.01	0.401	
	1.37e-3	0.401	
	9.414e-3	0.401	
	0.019	0.401	
	0.029	0.401	
	0.039	0.401	
	0.05	0.401	
	0.06	0.401	
	0.07	0.401	
	0.08	0.401	

X-axis factor: Id [-] Y-axis factor: Iq [-] Z-axis factor: Flux [-]

Data has 7621/30472 Records, 9 + 0 Variables, and 214 Tests.

Model-Based Calibration Workflow

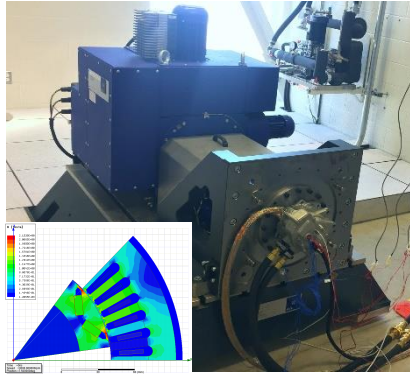

Data Collection

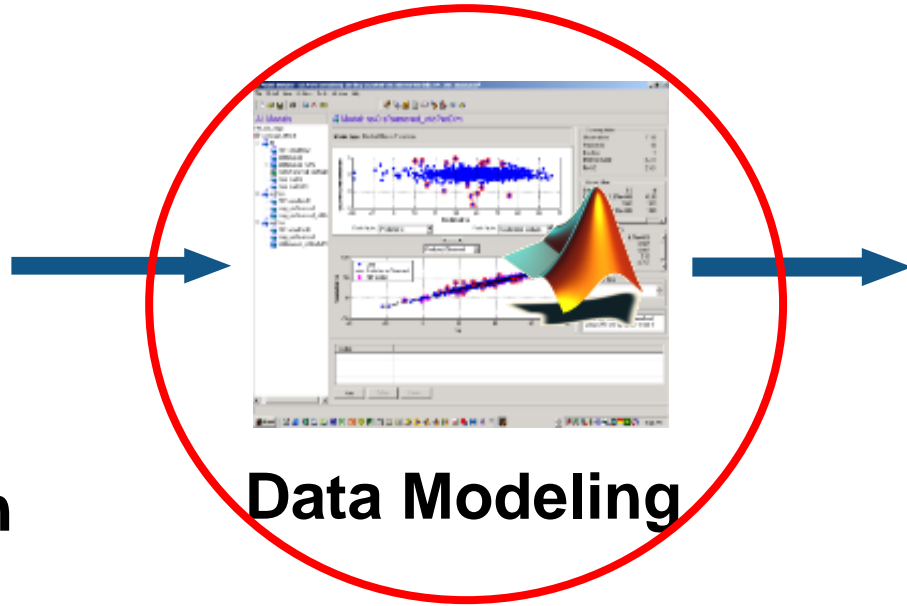

Data Modeling

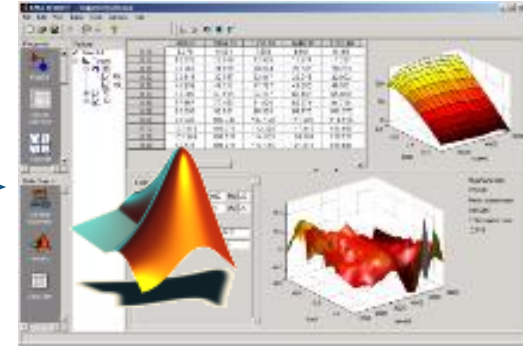

Calibration

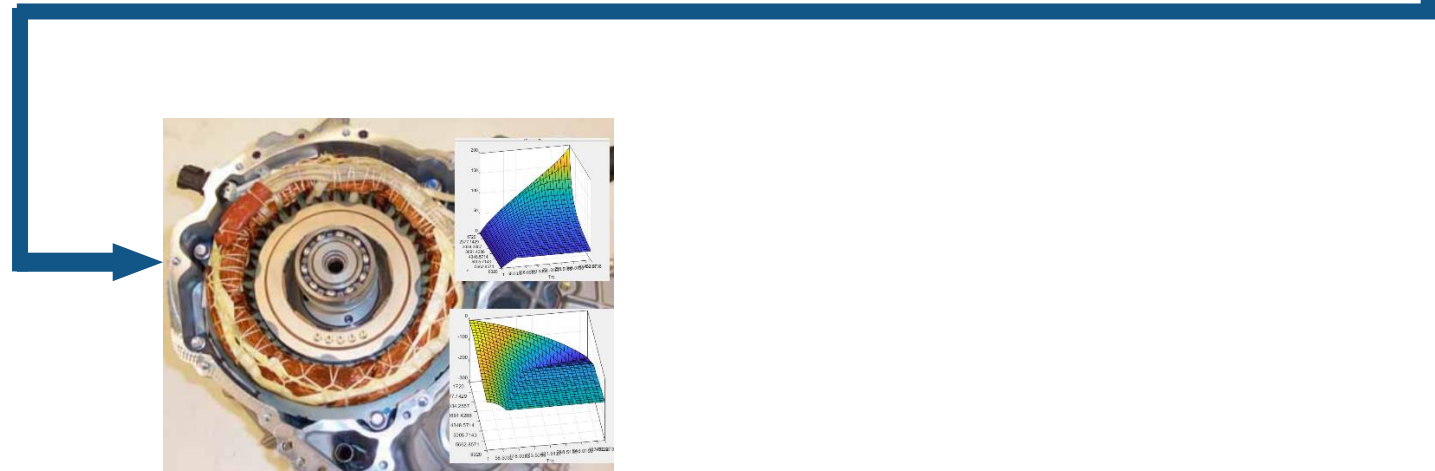

Implementation

Why Data Modeling?

Statistical models that map input variables to output responses

- Polynomials
- Radial Basis Functions
- Gaussian Process Models

Rationale

- Smooth raw data
- Interpolate between data points
- Reduce number of data points
- **Enable fast optimization**

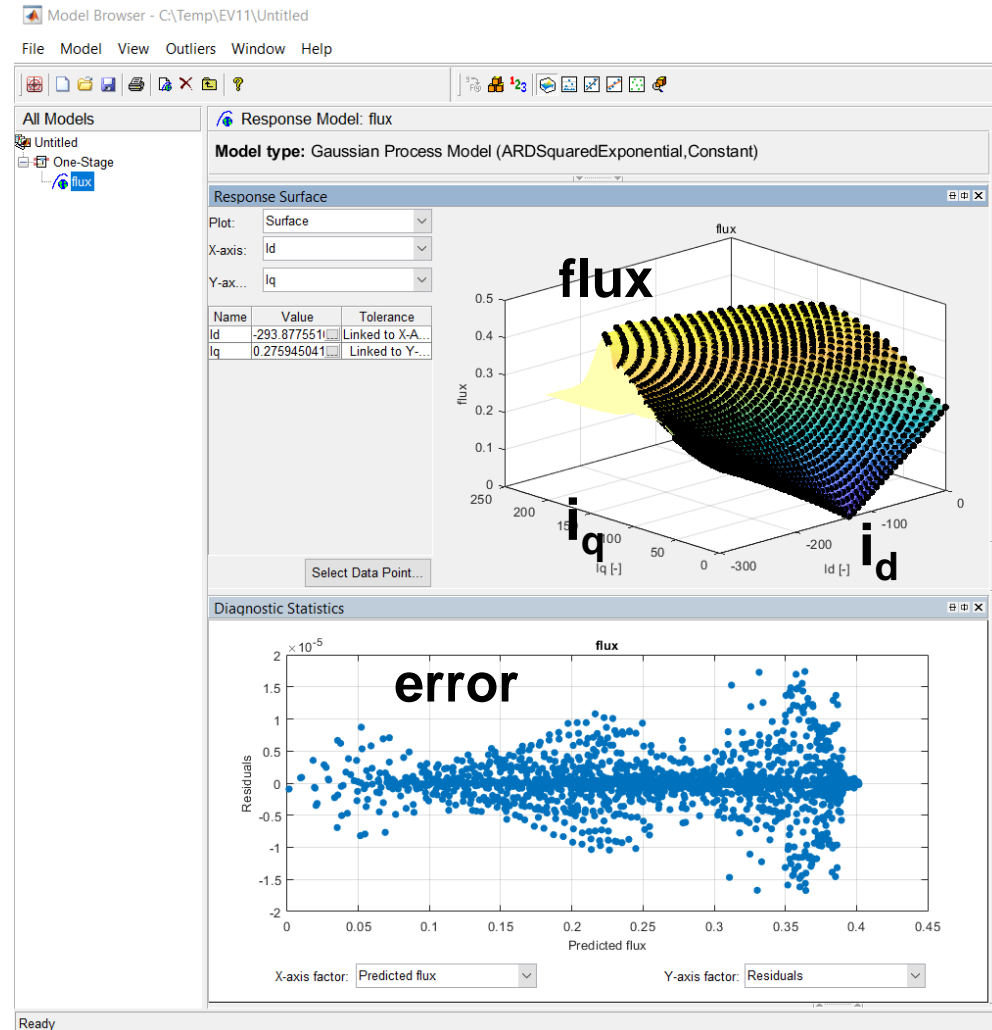
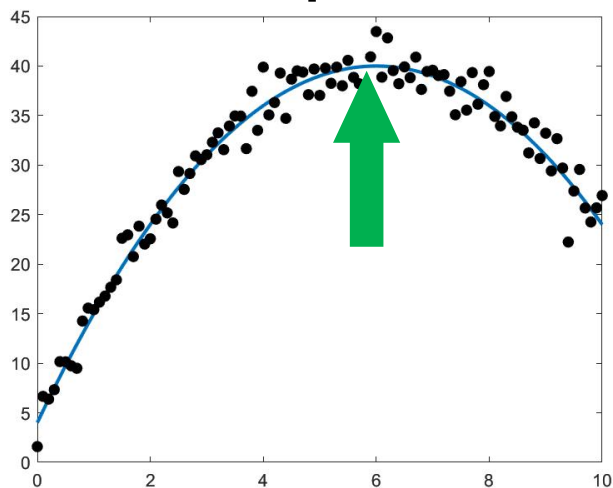

Data Modeling

Operating point **Trq rpm**

input

i_d



response

i_q

flux

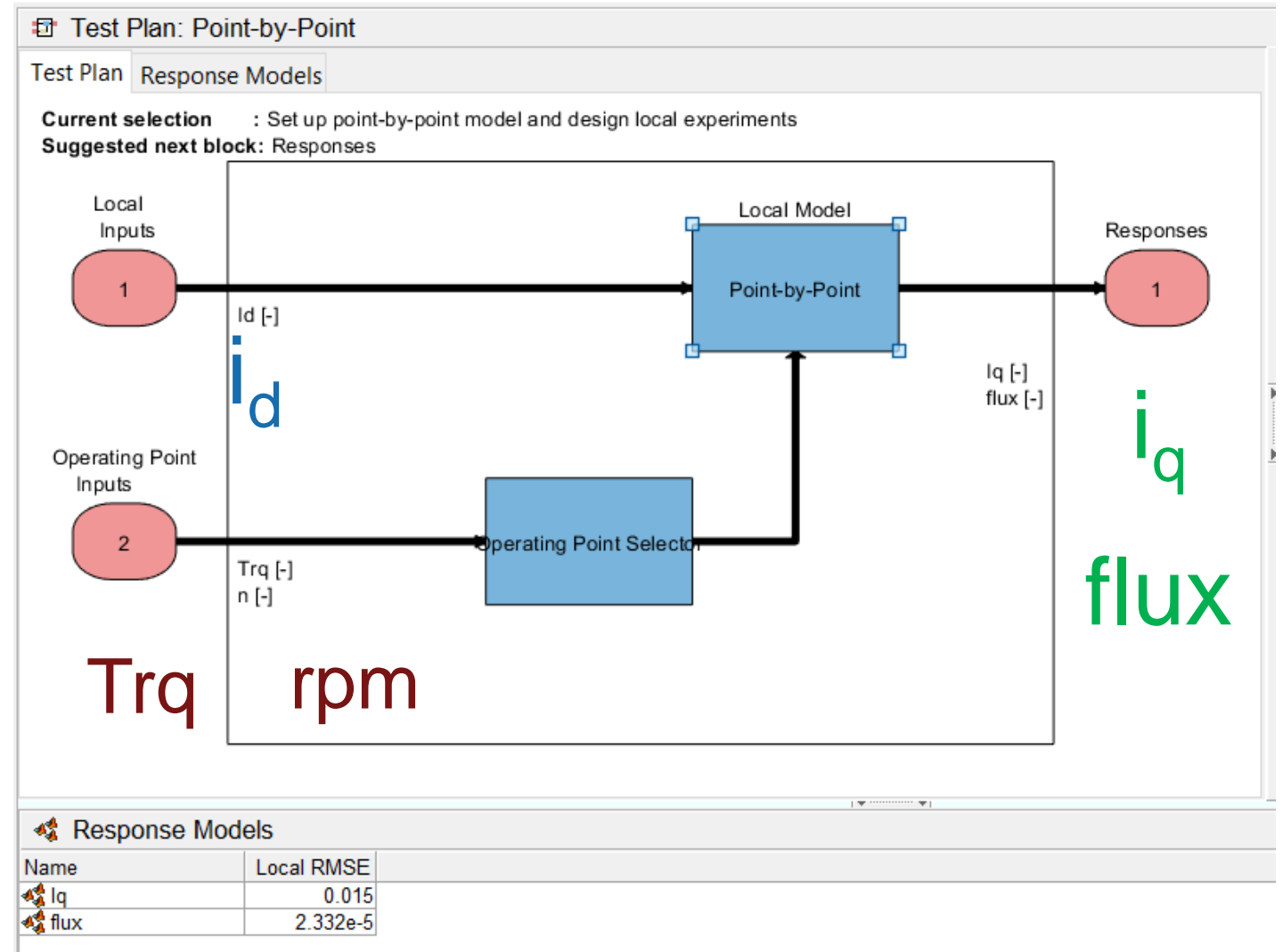

Model-Based Calibration Workflow

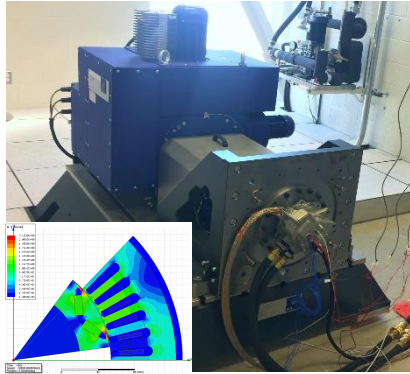

Data Collection

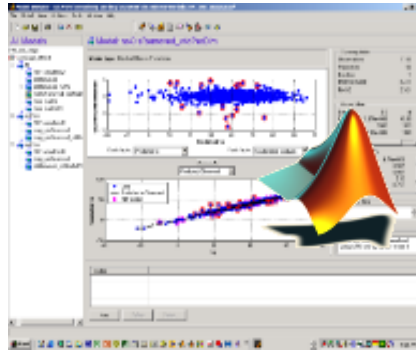

Data Modeling

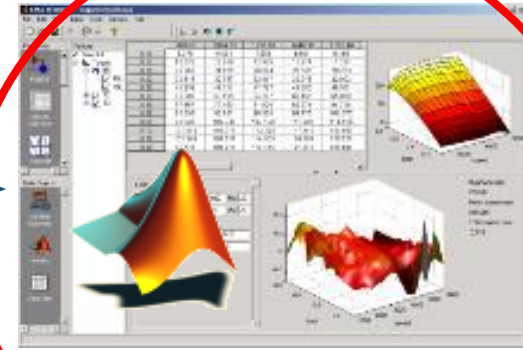

Calibration

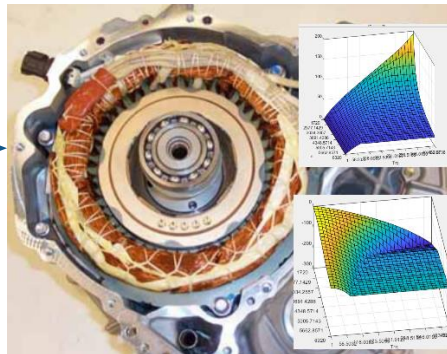

Implementation

Calibration

Given the fitted model, where is the best (i_d , i_q) operating points that can achieve pre-set optimization objective while satisfying certain physical constraints.

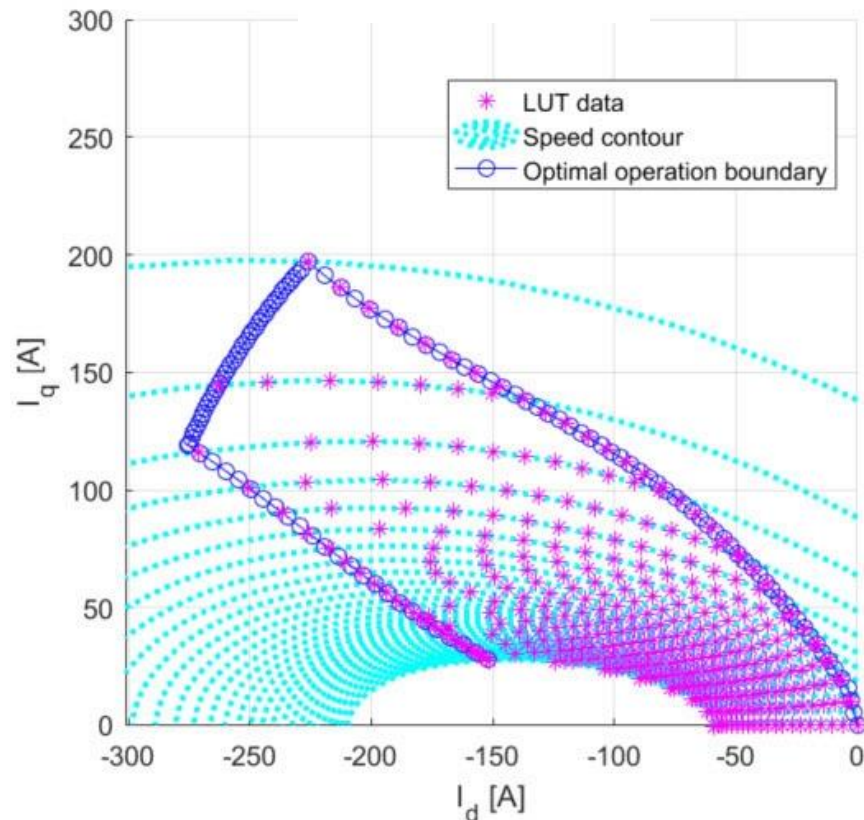

Optimization objective: maximize efficiency
(Torque per Amp)

Constraints: $\text{current} \leq \text{current_max}$
 $\text{flux} \leq \text{flux_allowed}$

Model-Based Calibration Workflow

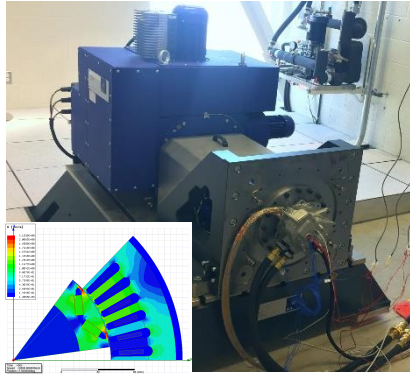

Data Collection

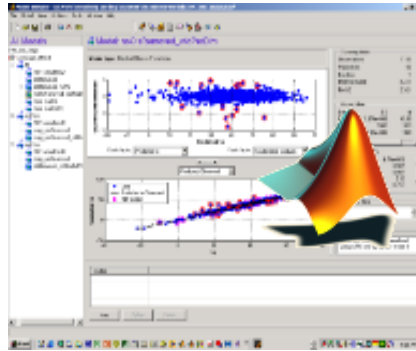

Data Modeling

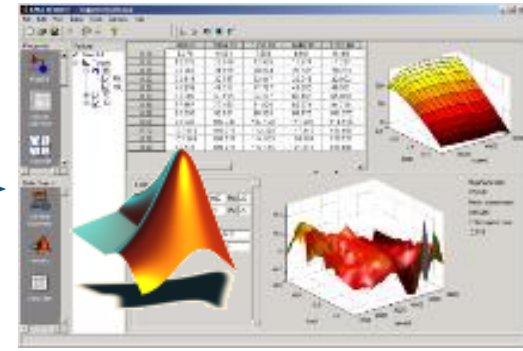

Calibration

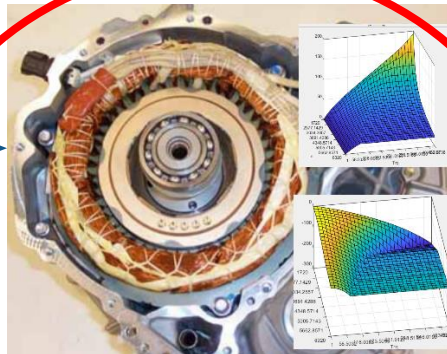

Implementation

Calibration Results – Fill Calibration Tables

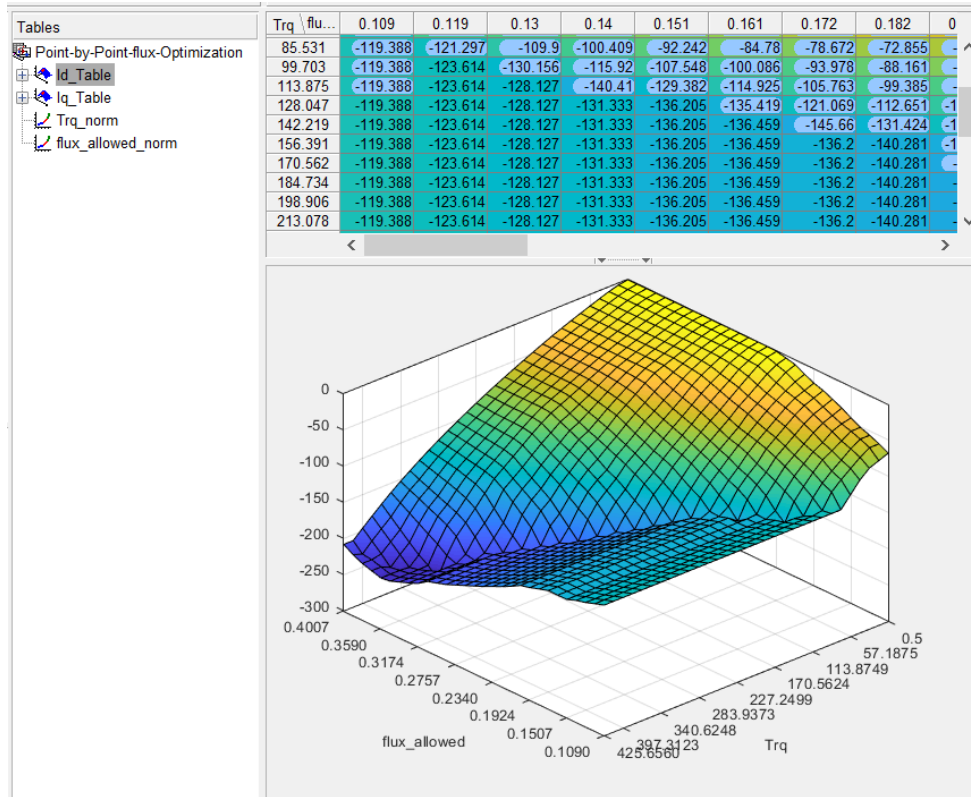

i_d table

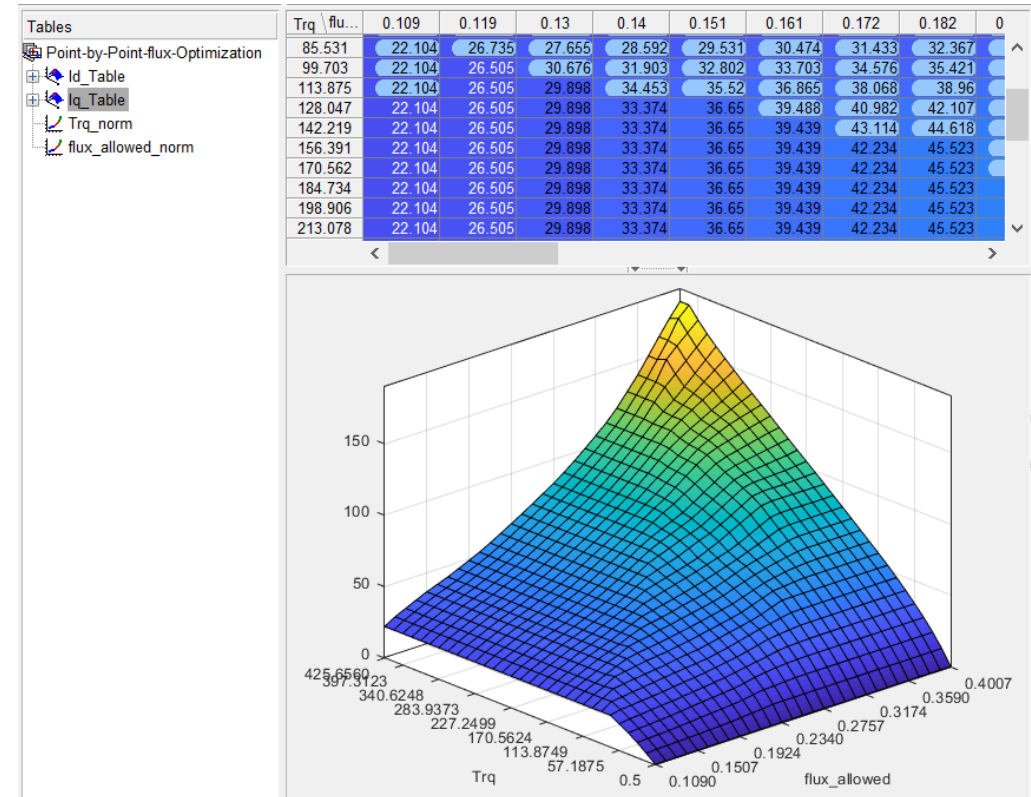

i_q table

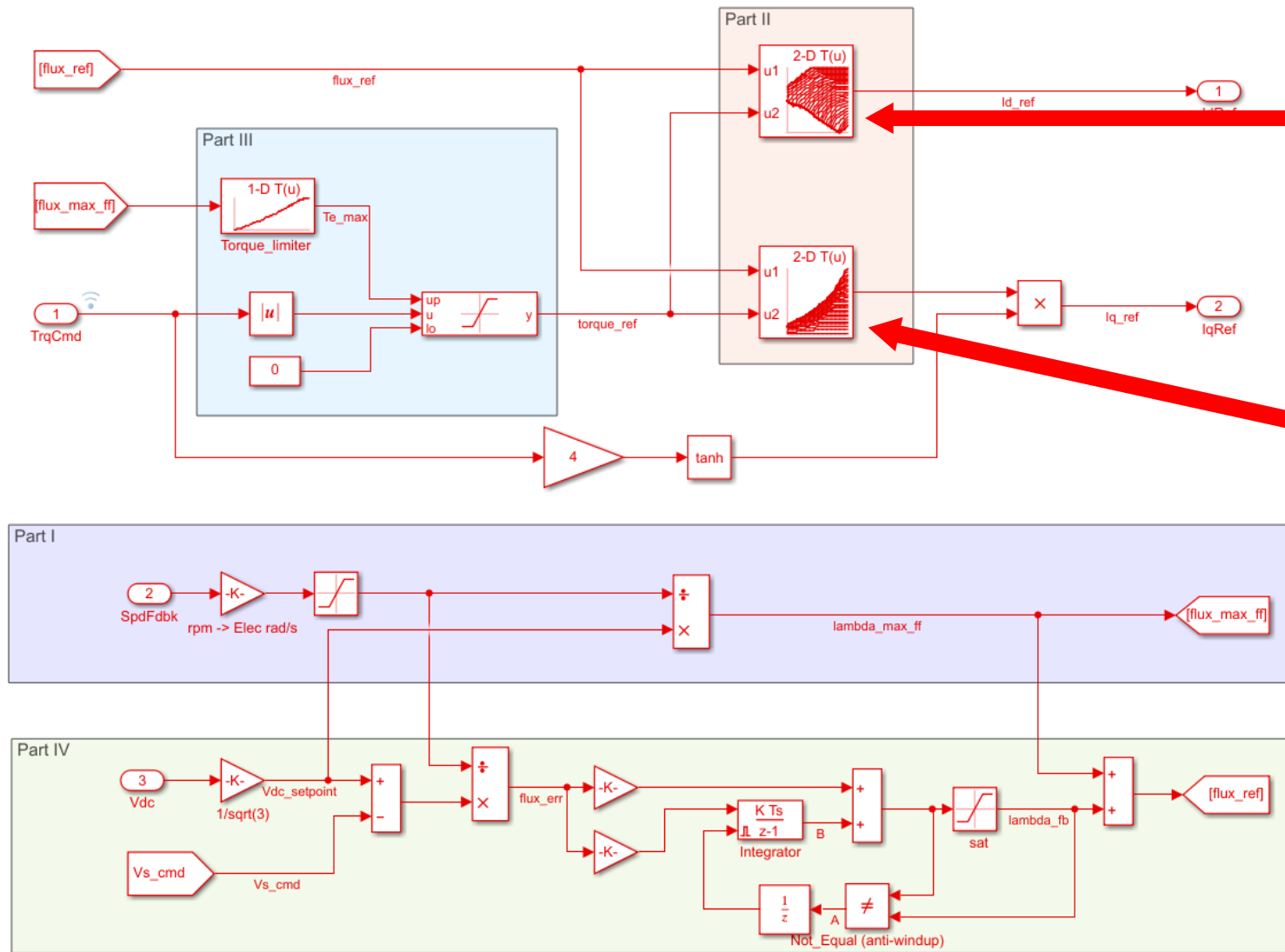

Tables

Trq_ref	Flux_ref	Id_ref	Iq_ref	Te_max	flux_max_ff	flux_err	lambda_fb	lambda_max_ff
0.100	0.119	0.13	0.14	0.15	0.16	0.17	0.18	0
81.511	0.119	0.13	0.14	0.15	0.16	0.17	0.18	0
89.703	0.119	0.13	0.14	0.15	0.16	0.17	0.18	0
113.875	0.119	0.13	0.14	0.15	0.16	0.17	0.18	0
138.047	0.119	0.13	0.14	0.15	0.16	0.17	0.18	0
162.219	0.119	0.13	0.14	0.15	0.16	0.17	0.18	0
186.391	0.119	0.13	0.14	0.15	0.16	0.17	0.18	0
210.563	0.119	0.13	0.14	0.15	0.16	0.17	0.18	0
234.735	0.119	0.13	0.14	0.15	0.16	0.17	0.18	0
258.907	0.119	0.13	0.14	0.15	0.16	0.17	0.18	0

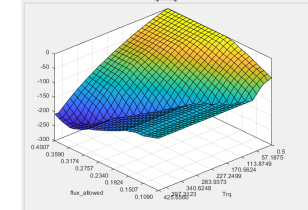

Tables

Trq_ref	Flux_ref	Id_ref	Iq_ref	Te_max	flux_max_ff	flux_err	lambda_fb	lambda_max_ff
0.100	0.119	0.13	0.14	0.15	0.16	0.17	0.18	0
81.511	0.119	0.13	0.14	0.15	0.16	0.17	0.18	0
89.703	0.119	0.13	0.14	0.15	0.16	0.17	0.18	0
113.875	0.119	0.13	0.14	0.15	0.16	0.17	0.18	0
138.047	0.119	0.13	0.14	0.15	0.16	0.17	0.18	0
162.219	0.119	0.13	0.14	0.15	0.16	0.17	0.18	0
186.391	0.119	0.13	0.14	0.15	0.16	0.17	0.18	0
210.563	0.119	0.13	0.14	0.15	0.16	0.17	0.18	0
234.735	0.119	0.13	0.14	0.15	0.16	0.17	0.18	0
258.907	0.119	0.13	0.14	0.15	0.16	0.17	0.18	0

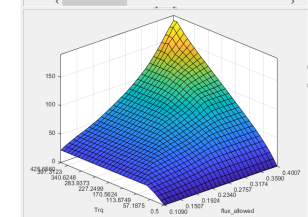

Takeaways

Model-based calibration workflow

- PMSM control calibration → optimization problem
- Automated calibration process
- Robust to different PMSM designs

Manual	Model-Based Calibration
Rule-based searching method -	Optimization +
Requires lots of scripting -	Automated +
Error prone -	Robust +

PMSM Calibration Consulting Service

- Service components
 - Hands on calibration support
 - Workflow discussion
 - Coaching of MBC calibration method
 - Calibration workflow tool
 - GUI that implements the entire MBC workflow

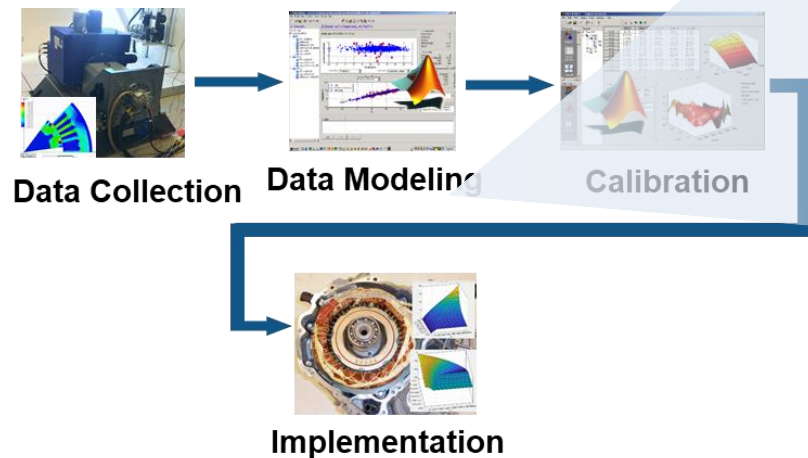

Calibration Workflow

Visualization

Contacts

dakaihu@mathworks.com

jgazzarr@mathworks.com