

Full Vehicle Simulation for Electrified Powertrain Selection

MathWorks Automotive Conference

April 11, 2019

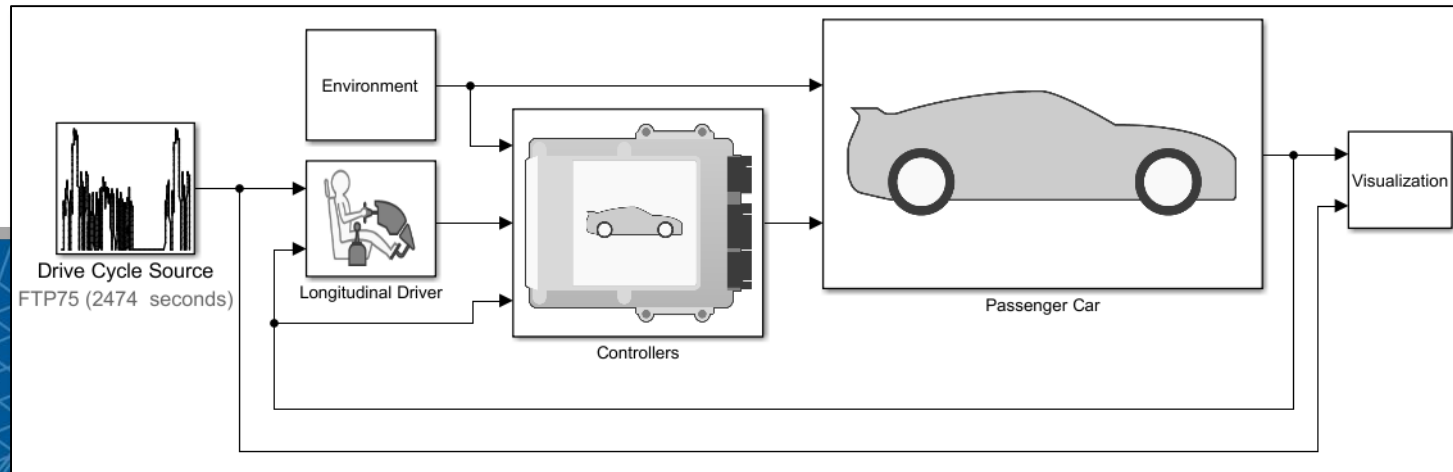
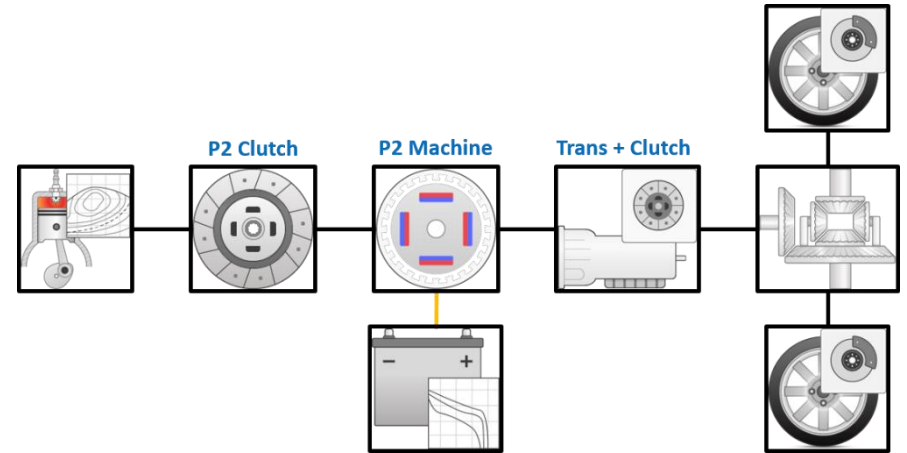

Eva Pelster, Application Engineer

Key Points

- Customize pre-built vehicle models to assess electrified powertrain variants
- Apply optimal control techniques to make fair comparisons
- Quantify tradeoffs between fuel economy and performance

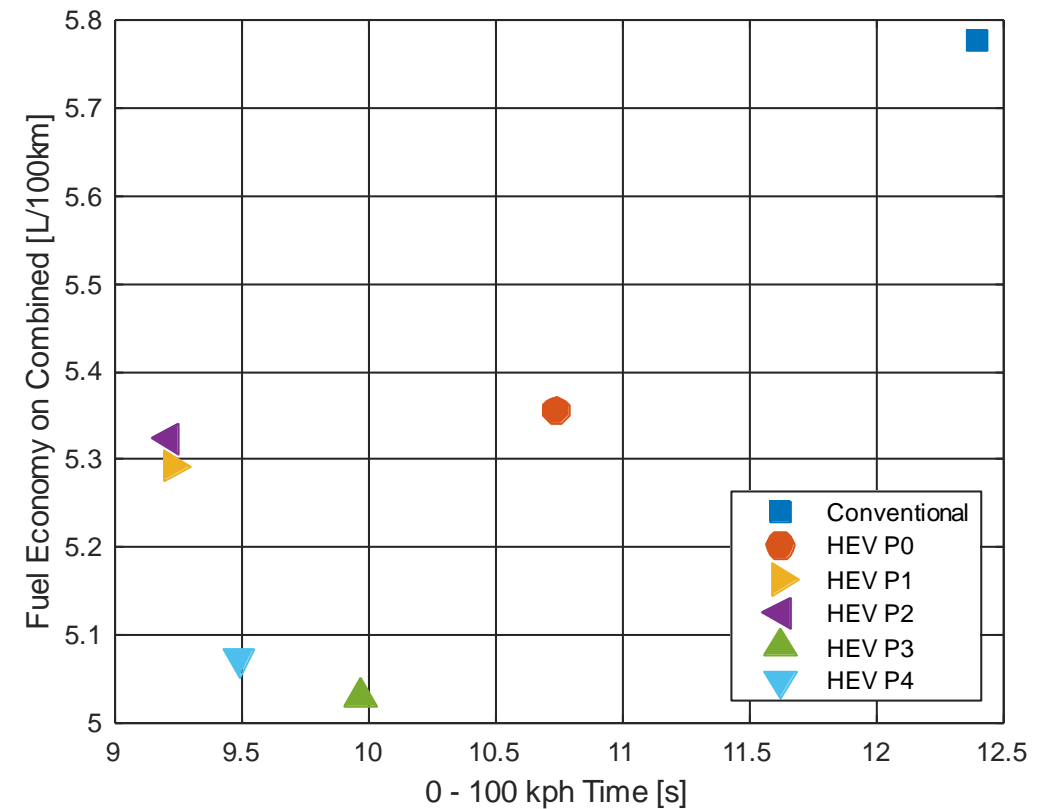
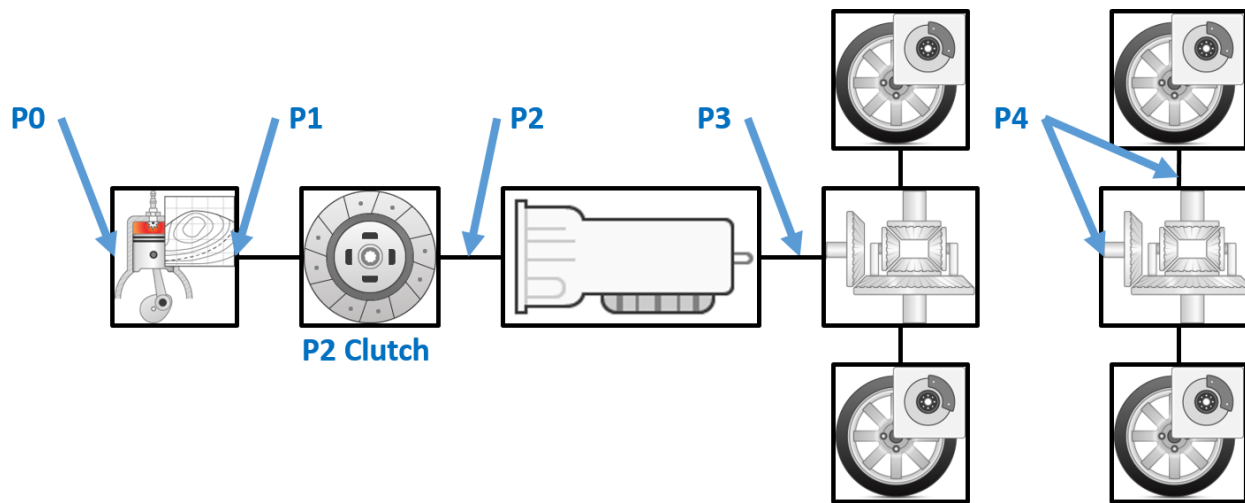

Agenda

- Context
- Case study description
- Tools used
- Plant model and controls
- Results
- Next steps

What Is Meant By “Full Vehicle Simulation”?

- Plant model + closed-loop control algorithms
 - Production code out of scope for today’s presentation (OBD, timing, etc.)
- Right balance of accuracy / speed
 - Sufficient detail for attribute analysis (fuel economy, performance, drivability, ...)
 - Fast enough for design optimization (much faster than real-time)
- Heterogeneous modeling environment
 - Support for inclusion of 3rd party simulation tools (S-function, FMU, ...)

Simulink as a Simulation Integration Platform

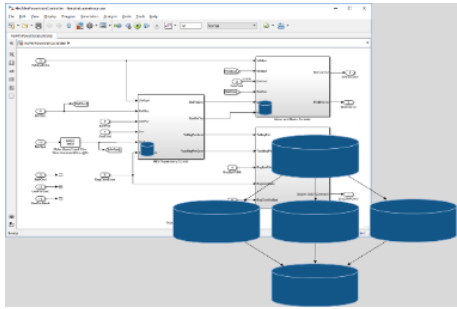

Data Management

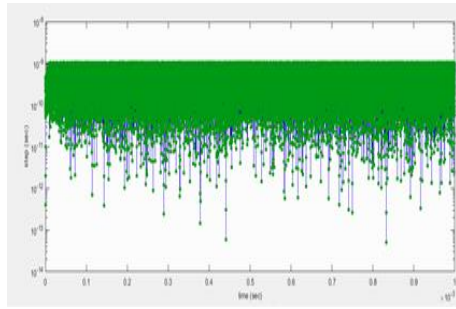

Solver Technology

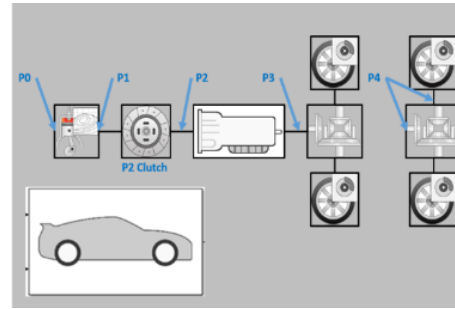

Vehicle Configuration

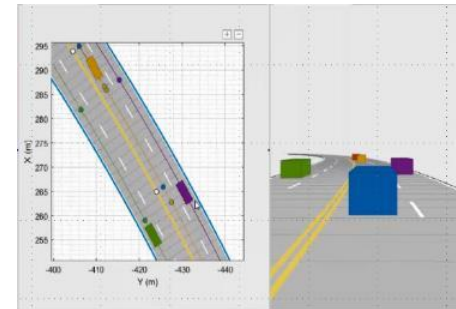

Multi-actor Scenarios

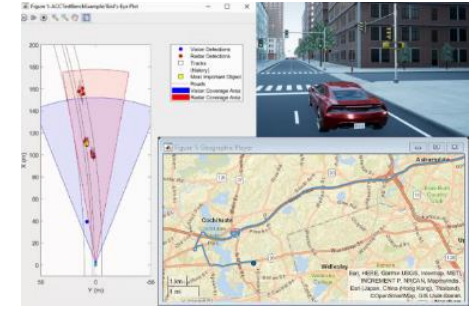

Visualization

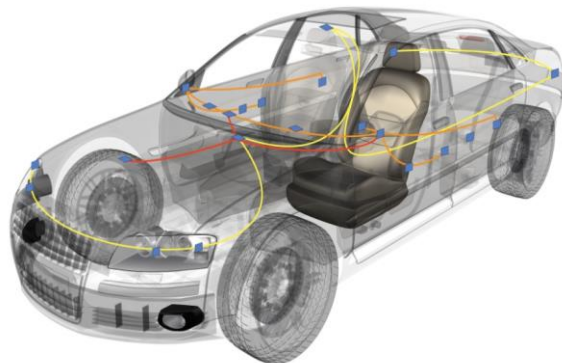
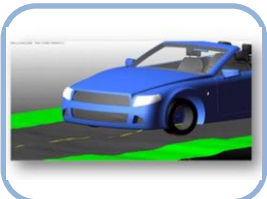
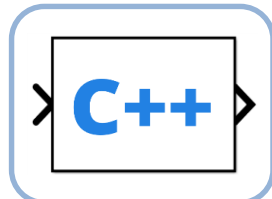
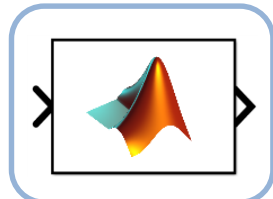

Simulink

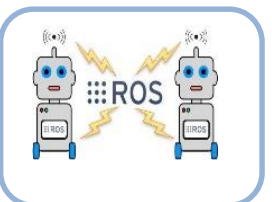
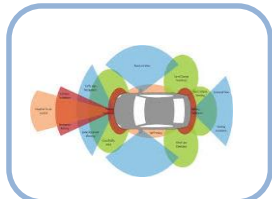
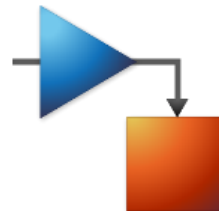

Agenda

- Context
- Case study description
- Tools used
- Plant model and controls
- Results
- Next steps

Electrified Powertrain Selection

- Considering variants of single motor, parallel hybrids
- Where is the best location for the motor?

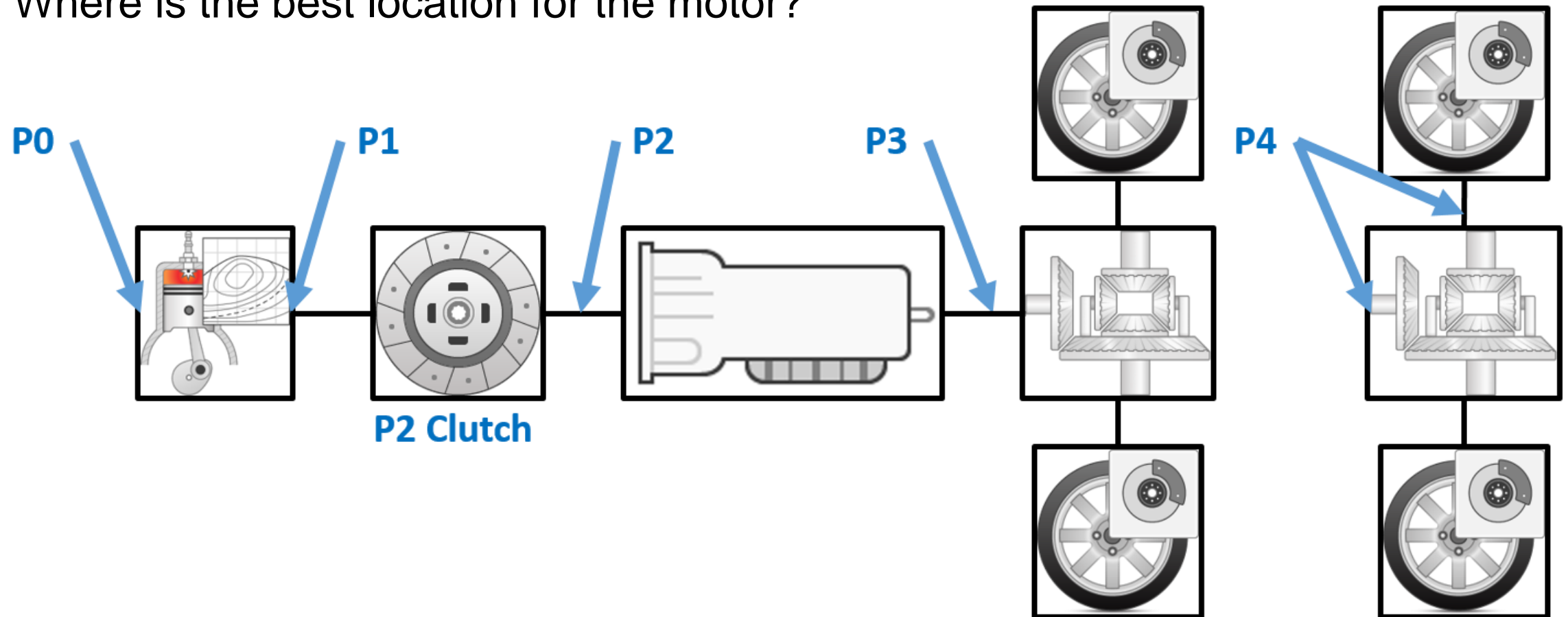

Problem Statement

- Maximize:
 - Fuel economy (l/100km for drive cycles Highway, City, US06)
 - Acceleration performance ($t_{0-100\text{km/h}}$)

- Subject to:
 - Actuator limits for motor & engine
 - Velocity within 3,2 km/h window of drive cycle target velocity
 - SOC within $[\text{SOC}_{\text{low}}, \text{SOC}_{\text{high}}]$
 - $|\text{SOC}_{\text{final}} - \text{SOC}_{\text{init}}| < \text{tol}$ → **requires iteration on supervisory control parameter**

Agenda

- Context
- Case study description
- Tools used
- Plant model and controls
- Results
- Next steps

Powertrain Blockset

- Goals:
 - Provide starting point for engineers to build **good plant / controller models**
 - Provide **open** and documented models
 - Provide very **fast**-running models that work with popular HIL systems

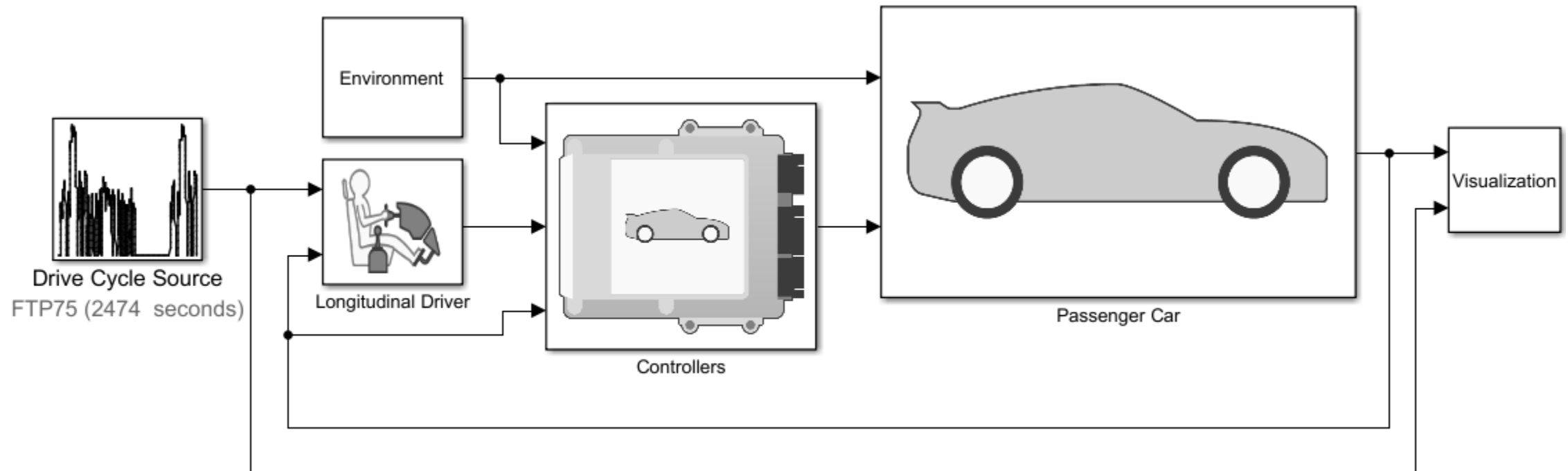

Lower the barrier to entry for Model-Based Design

Powertrain Blockset Features

Library of blocks

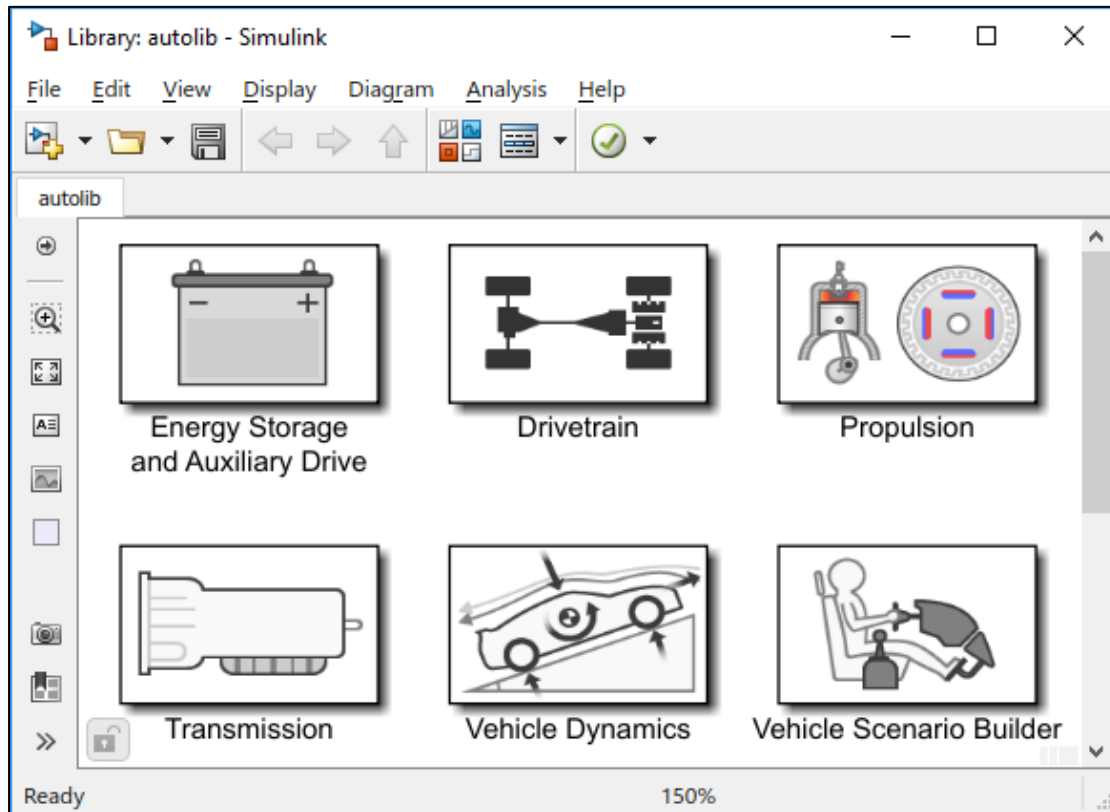

Pre-built reference applications

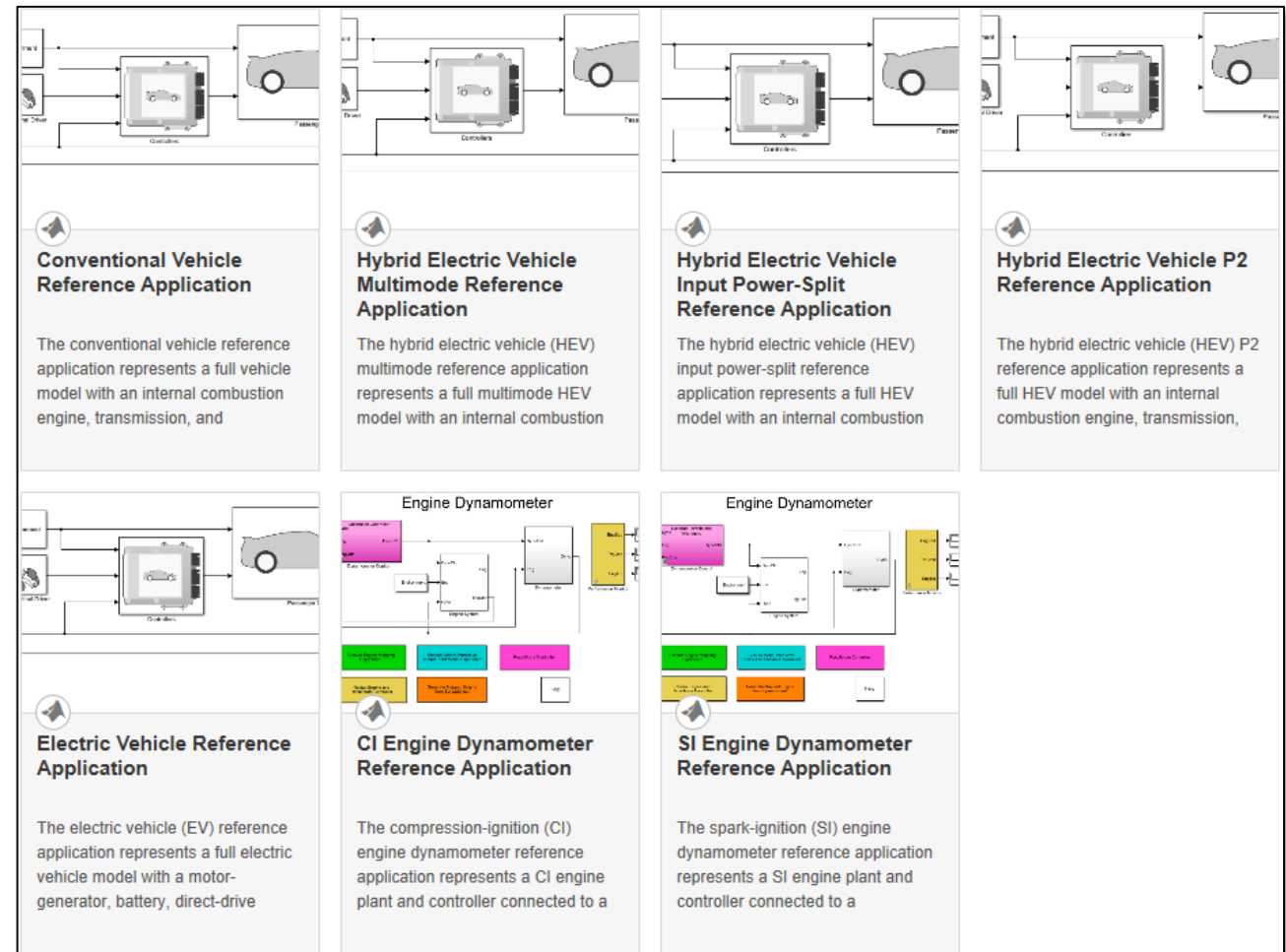

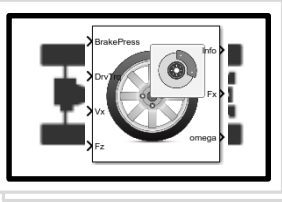

Drivetrain

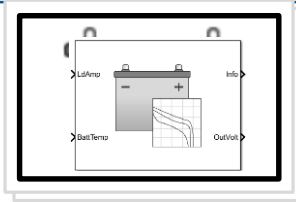

Energy Storage and Auxiliary Drive

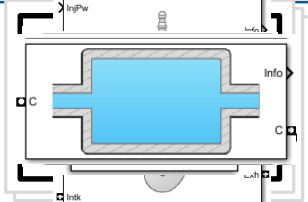

Propulsion

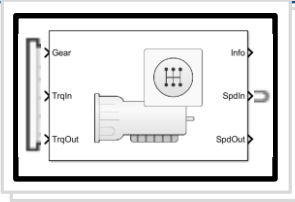

Transmission

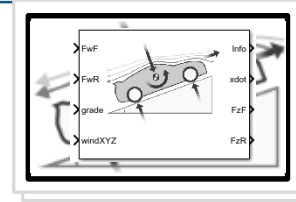

Vehicle Dynamics

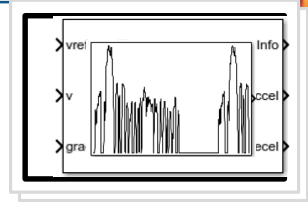

Vehicle Scenario Builder

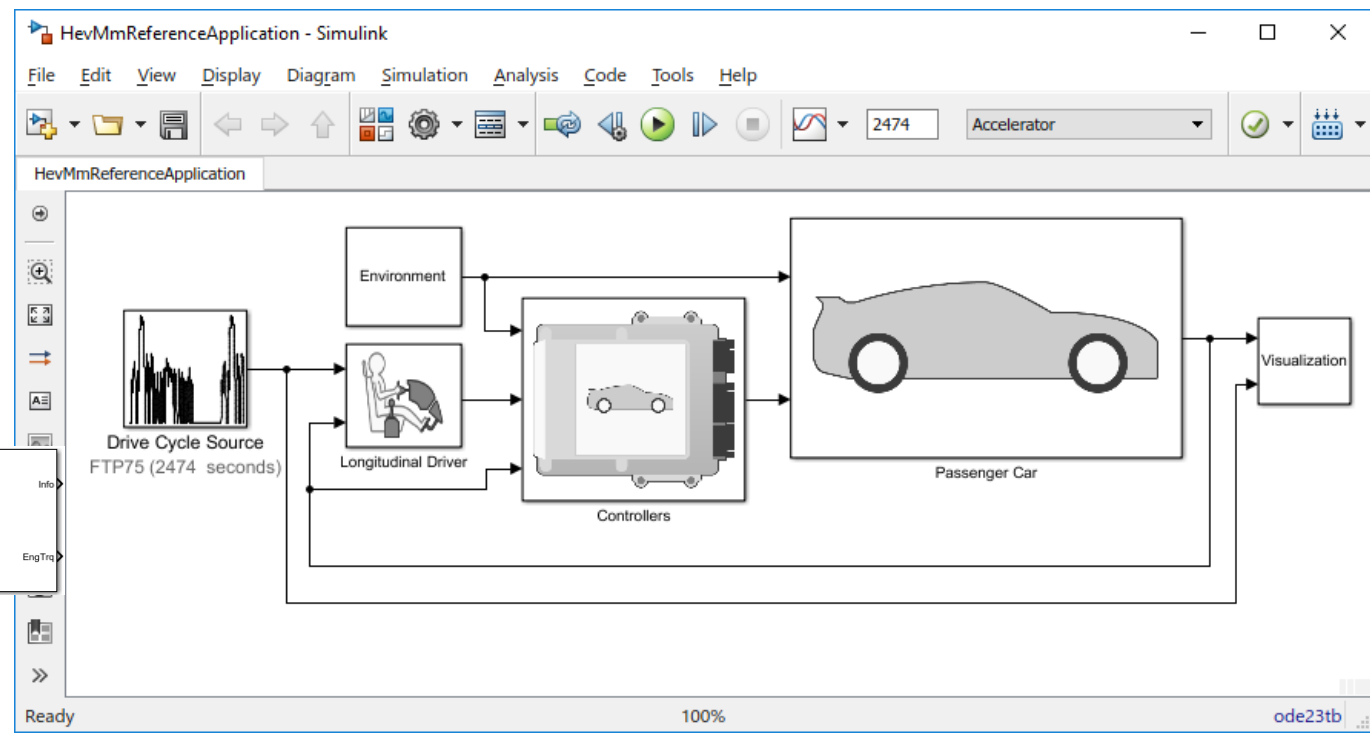
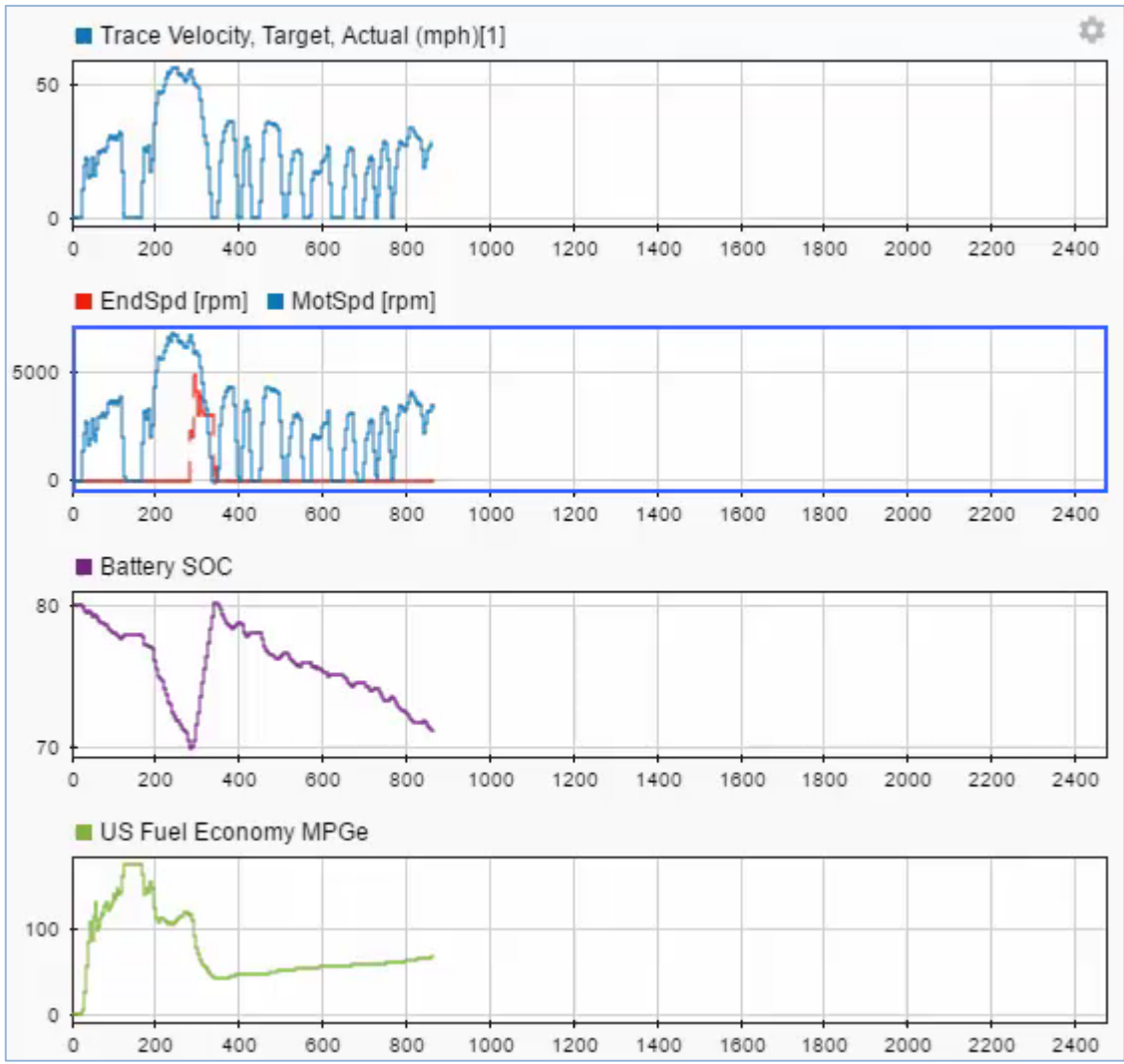

Reference Applications

Full Vehicle Models

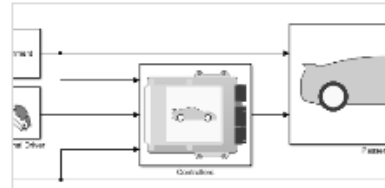

Conventional Vehicle Reference Application

The conventional vehicle reference application represents a full vehicle model with an internal combustion engine, transmission, and

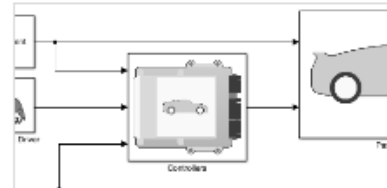

Hybrid Electric Vehicle Multimode Reference Application

The hybrid electric vehicle (HEV) multimode reference application represents a full multimode HEV model with an internal combustion

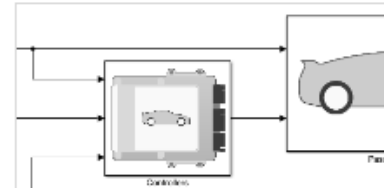

Hybrid Electric Vehicle Input Power-Split Reference Application

The hybrid electric vehicle (HEV) input power-split reference application represents a full HEV model with an internal combustion

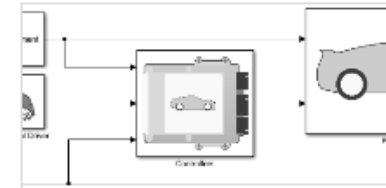

Hybrid Electric Vehicle P2 Reference Application

The hybrid electric vehicle (HEV) P2 reference application represents a full HEV model with an internal combustion engine, transmission,

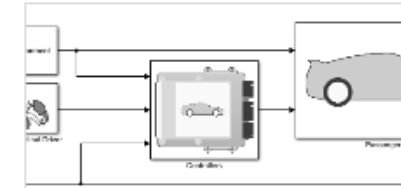

Electric Vehicle Reference Application

The electric vehicle (EV) reference application represents a full electric vehicle model with a motor-generator, battery, direct-drive

Virtual Engine Dynamometers

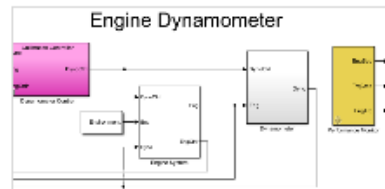

CI Engine Dynamometer Reference Application

The compression-ignition (CI) engine dynamometer reference application represents a CI engine plant and controller connected to a

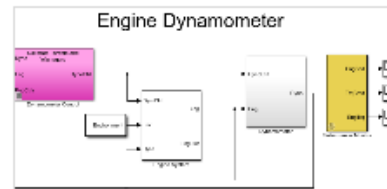

SI Engine Dynamometer Reference Application

The spark-ignition (SI) engine dynamometer reference application represents a SI engine plant and controller connected to a

What's New in R2018b ?

Engine Test Data Import

The screenshot illustrates the integration of engine test data into a Simulink model. On the left, an Excel spreadsheet (SiEngineData.xlsx) contains the following data:

Name:	Torque	EngSpd	AirMassFlwRate	FuelMassFlwRate	ExhTemp	BSFC
Unit:	N*m	rpm	kg/s	kg/s	K	g/(kW
Data:	33.598	750	0.003756044	0.000257263	767.6445	350.97
	45.847	750	0.004654959	0.000318832	788.1032	318.76
	56.568	750	0.005485734	0.000375735	800.8691	304.45
	68.245	750	0.006440062	0.0004411	880.7776	296.26
	76.223	750	0.007074802	0.000484576	909.6978	291.3
	76.223	750	0.007074794	0.000484575	909.6971	291.39
	28.544	1053.6	0.00502789	0.000344376	864.1794	393.66
	40.024	1053.6	0.005905243	0.000404469	877.6878	329.91
	51.453	1053.6	0.006903229	0.000472824	886.9836	299.89
	62.881	1053.6	0.008056477	0.000551813	900.5524	286.35
	74.31	1053.6	0.009218835	0.000631427	919.7863	277.26
	85.738	1053.6	0.010556639	0.000723057	990.6683	275.16
	95.025	1053.6	0.012052329	0.000825519	1071.628	283.46
	24.676	1357.1	0.005875772	0.00040245	901.2477	413.12
	36.983	1357.1	0.007204383	0.000493451	921.4745	338.20
	48.412	1357.1	0.008373948	0.000573558	926.201	300.20794
	59.84	1357.1	0.0097533	0.000668034	941.4953	282.79031
	71.269	1357.1	0.011219721	0.000768474	955.8058	273.14525
	82.697	1357.1	0.012688208	0.000869055	969.9667	266.19969

The Simulink model (SiMappedEngine) features a 'Mapped SI Engine' block that receives inputs: TrqCmd (15), EngSpd (18), ThrPosPct (5), and VgAreaPct (6). The engine outputs engine speed (EngSpd) and torque (EngTrq). These are combined with an 'Accessory Load Model' to produce 'Net Torque'. The engine also outputs various parameters: <ExhManG>, <Afr>, <Bsfc>, <EoHC>, <EoCO>, and <EoNOx>.

What's New in R2019a ?

Energy Accounting and Reporting

Simulate

- Turn on logging
- Run simulation
- Check conservation of energy

Live Editor - GenerateEnergyReport.mlx Project - HEVIPS

Run Simulation

Click **Run** to create an `autoblks.pwr.PlantInfo` object that analyzes the model energy consumption. Use the `PwrUnits` and `EngryUnits` properties to set the units.

After you run the simulation, the live script provides the energy summary. You can use the results to analyze energy and power losses at the component and system level. For more information, see [Explore the Hybrid Electric Vehicle Input Power-Split Reference Application](#).

```

1 SysName = 'HevIpsReferenceApplication';
2 VehPwrAnalysis = autoblks.pwr.PlantInfo(SysName);
3 VehPwrAnalysis.PwrUnits = 'kW';
4 VehPwrAnalysis.EngryUnits = 'MJ';

```

Use run method to turn on logging, run simulation, and add logged data to the object.

```

5 VehPwrAnalysis.run;

```

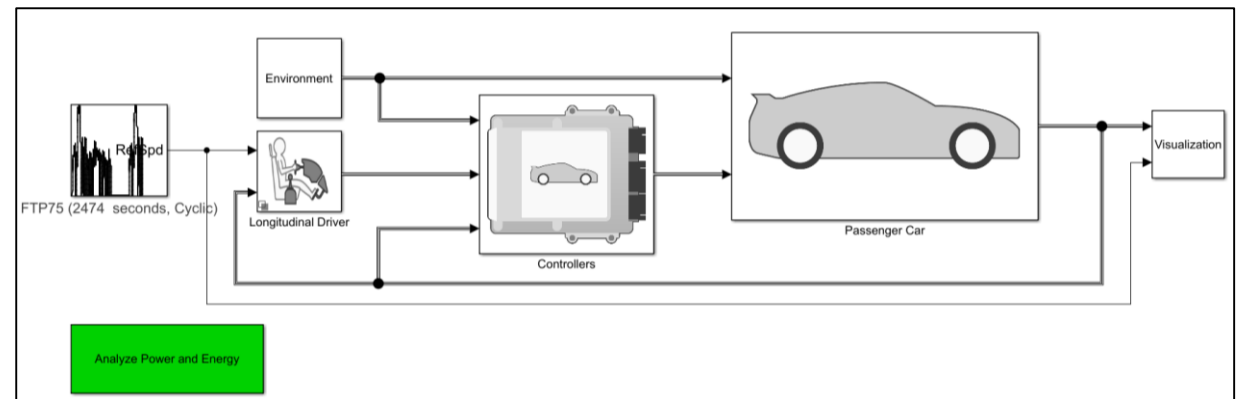

What's New in R2019a ?

Energy Accounting and Reporting

Simulate

- Turn on logging
- Run simulation
- Check conservation of energy

Report results

- System level summary
- Subsystem detailed view
- Excel export
- Efficiency histogram
- Time trace plots

Live Editor - GenerateEnergyReport.mlx

```

8 EngSysName = 'HevIpsReferenceApplication/Passenger Car/Engine';
9 EngPwrAnalysis = VehPwrAnalysis.findChildSys(EngSysName);
10 EngPwrAnalysis.dispSignalSummary;
                    
```

HevIpsReferenceApplication/Passenger Car/Engine
Average Efficiency = 0.24

Signal	Energy (MJ)

Inputs	
Transferred	32.2
Accessory Load Model: Engine output	0.124
Not transferred	0.124
Outputs	
Accessory Load Model: Engine output	-7.67
Losses	-7.67
Stored	-24.6
	0

Live Editor - GenerateEnergyReport.mlx

Overall Summary

Display the final energy values for each subsystem.

VehPwrAnalysis.dispSysSummary

System Name	Efficiency	Energy Loss (MJ)

HevIpsReferenceApplication	0.0418	-94.7
Passenger Car	0.0418	-94.7
Drivetrain	0.134	-68.8
Differential and Compliance	0.995	0
Front Axle Compliance 1	1	0
Front Axle Compliance 2	1	0
Open Differential	0.996	0
Gearbox	0.849	-2.33
P1	0.885	-1.16
P2	0.834	-1.16
Torque Coupler	1	0
		-1.68
		-1.68
		-64.7

Simulation Data Inspector - untitled*

Inspect Compare

Filter Signals

NAME

- HevIpsReferenceApplication
 - HevIpsReferenceApplication
 - Engine
 - Efficiency
 - Power
 - Energy
 - Electric Plant
 - Drivetrain

Archive (7)

Properties

	A	B	C	D	E	F
1	System Name	Efficiency	Energy Loss (MJ)	Energy In	Energy Ou	Energy Stored (MJ)
2	HevIpsReferenceApplication	0.04	-94.70	32.85	0.00	-61.86
3	Passenger Car	0.04	-94.70	32.85	0.00	-61.86
4	Drivetrain	0.13	-68.78	12.60	-5.61	-61.84
5	Differential and Compliance	1.00	-0.05	9.87	-9.82	0.00
6	Front Axle Compliance 1	1.00	0.00	4.92	-4.92	0.00
7	Front Axle Compliance 2	1.00	0.00	4.92	-4.92	0.00
8	Open Differential	1.00	-0.04	9.87	-9.83	0.00
9	Gearbox	0.85	-2.33	14.83	-12.50	0.00
10	P1	0.88	-1.16	9.53	-8.37	0.00
11	P2	0.83	-1.16	6.95	-5.78	0.00
12	Torque Coupler	1.00	0.00	11.52	-11.52	0.00
13	Vehicle	0.85	-1.68	6.53	-4.82	0.02
14	Vehicle Body 3 DOF Longitudina	0.85	-1.68	6.53	-4.82	0.02
15	Wheels and Brakes	0.13	-64.73	12.36	-9.49	-61.86
16	Longitudinal Wheel - Front 1	0.24	-14.78	5.65	-4.65	-13.78

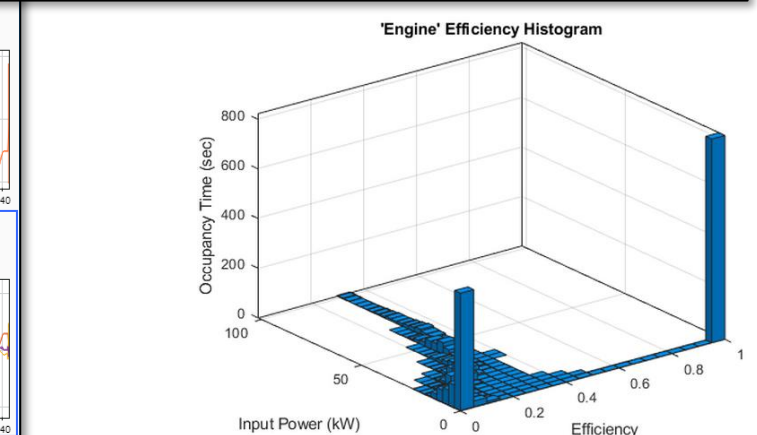

Agenda

- Context
- Case study description
- Tools used
- Plant model and controls
- Results
- Next steps

EV / HEV Configurations Shipping with Powertrain Blockset

Pure EV

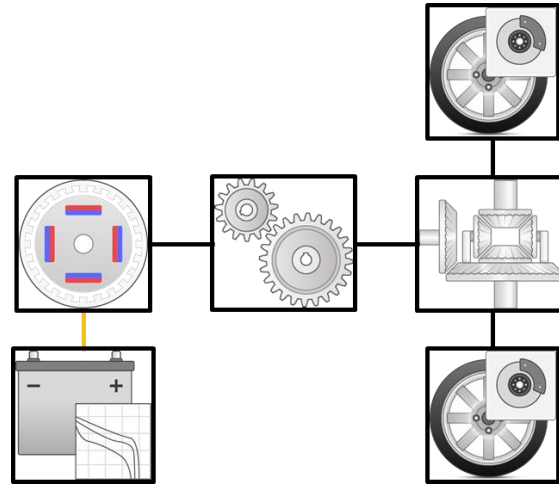

- Released in: **R2016b**
- Similar powertrains:
 - Nissan Leaf
 - Tesla Roadster
 - Chevy Bolt

Multi-mode HEV → P1/P3

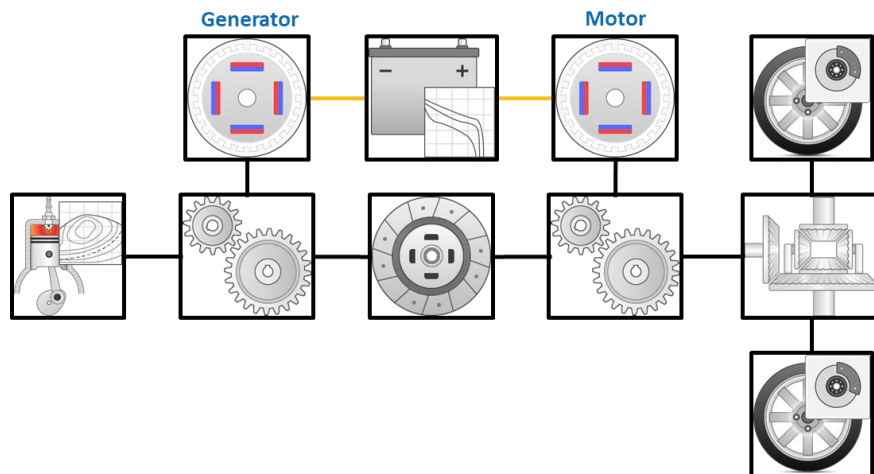

- Released in: **R2016b**
- Similar powertrains:
 - Hybrid Honda Accord

EV / HEV Configurations Shipping with Powertrain Blockset

Input Power-Split HEV

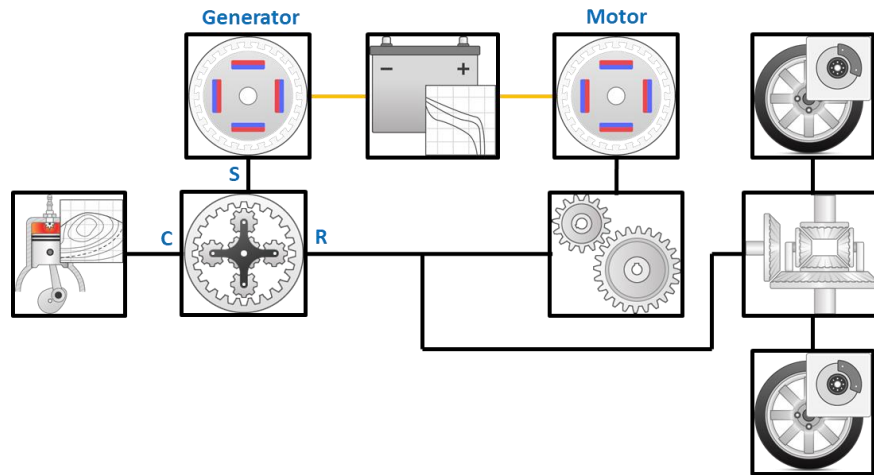

- Released in: **R2017b**
- Similar powertrains:
 - Toyota Prius
 - Lexus Hybrid
 - Ford Hybrid Escape

P2 HEV

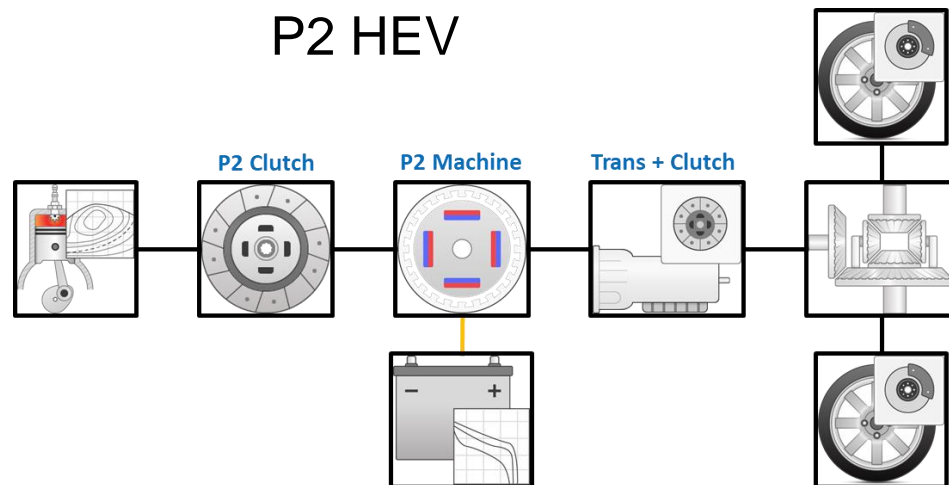

- Released in: **R2018b**
- Similar powertrains:
 - Nissan Pathfinder
 - Hyundai Sonata
 - Kia Optima

Flexible Modeling Framework

1. Choose a vehicle configuration

- Select a reference application as a starting point

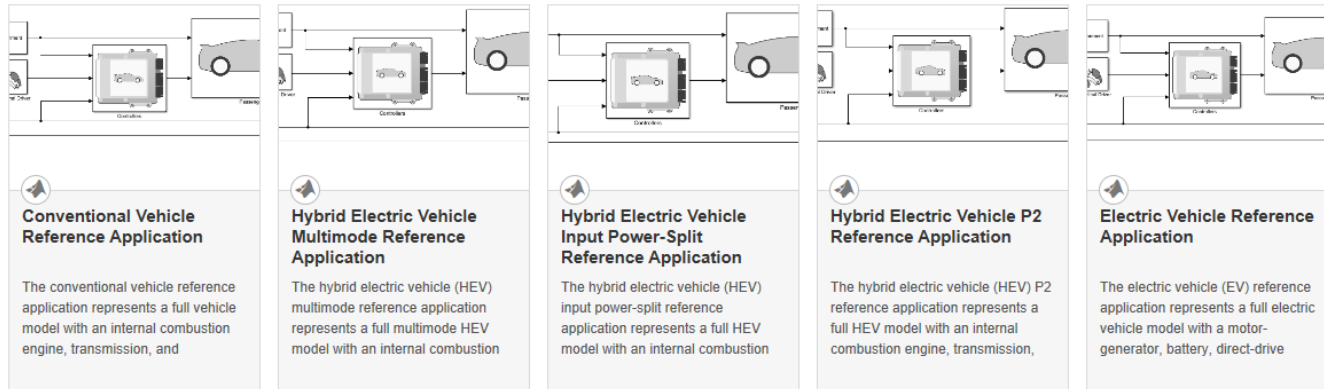

2. Customize the plant model

- Parameterize the components
- Customize existing subsystems
- Add your own subsystem variants

3. Customize the controllers

- Parameterize the controllers
- Customize supervisory control logic
- Add your own controller variants

4. Perform closed-loop system testing

- Sensitivity analyses
- Design optimization
- MIL / SIL / HIL testing

EcoCAR: Mobility Challenge



GENERAL MOTORS



- What is it?
 - Student competition for 12 North American universities
 - Collaboration of industry, academia and government research labs
 - Improve fuel economy through hybridization and enable level 2 automation capabilities
- MathWorks provided Powertrain Blockset reference applications:
 - Plant models for P0 – P4 architectures
 - Supervisory controller
- Work reused as starting point for powertrain for this work

Plant Model: System level

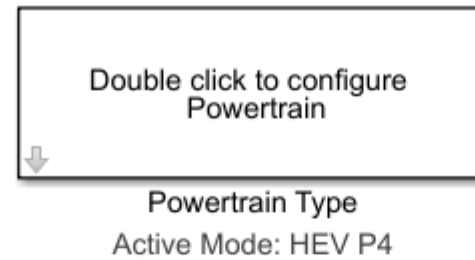

Block Parameters: Powertrain Type

Drivetrain Configuration (mask)
Use this block to configure the drivetrain mode.

Parameters

Powertrain Mode: HEV P4

- Conventional
- HEV P0
- HEV P1
- HEV P2
- HEV P3
- HEV P4

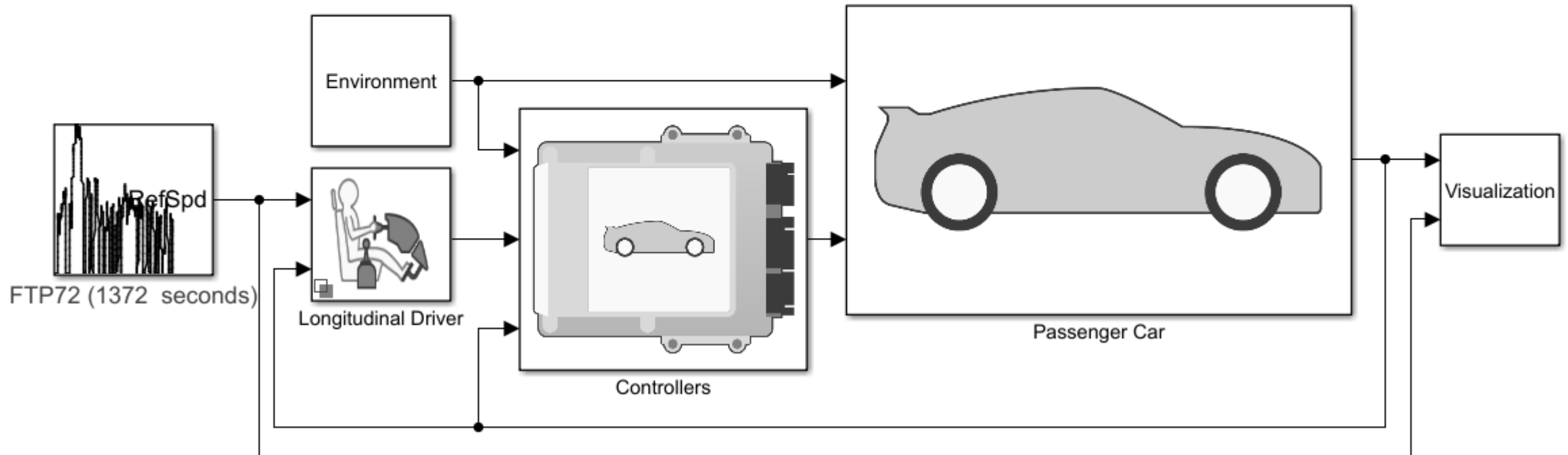

Plant Model: Engine Subsystem

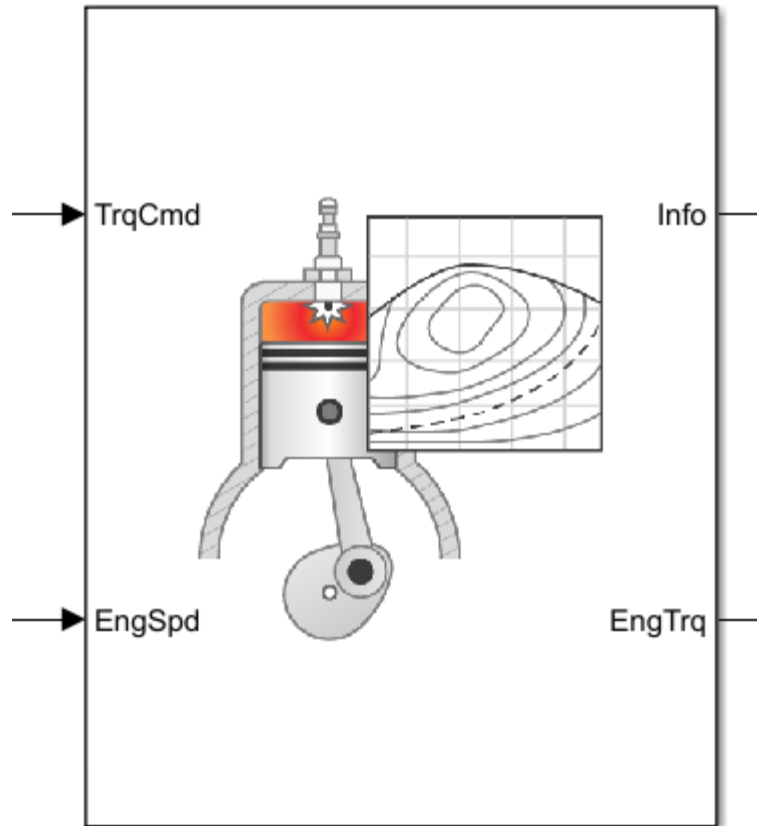

1.5L Gasoline Engine

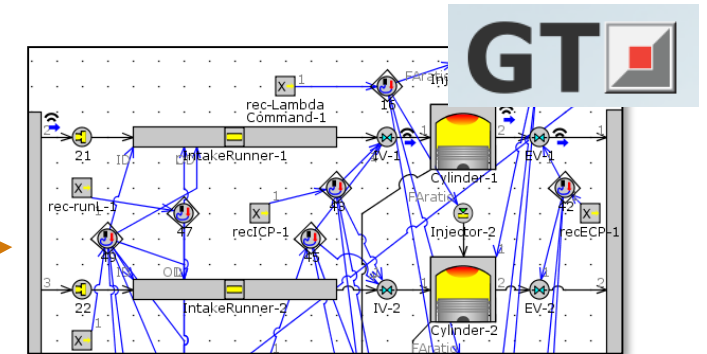
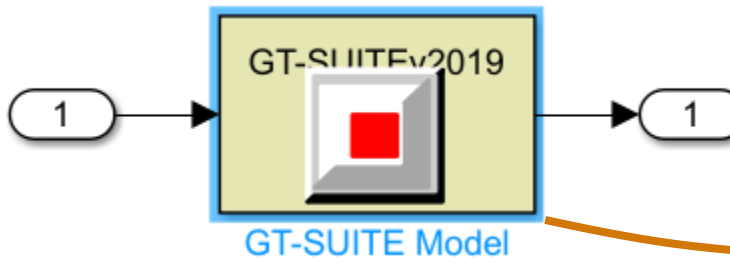
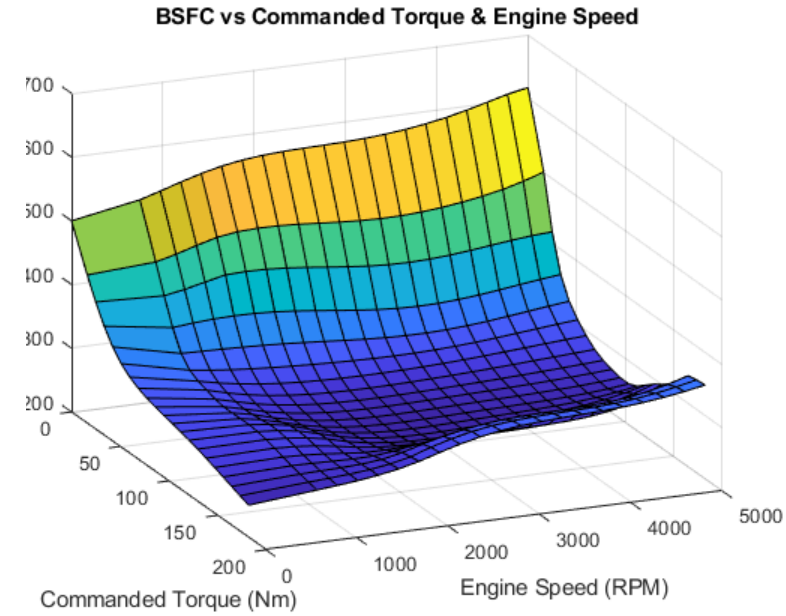
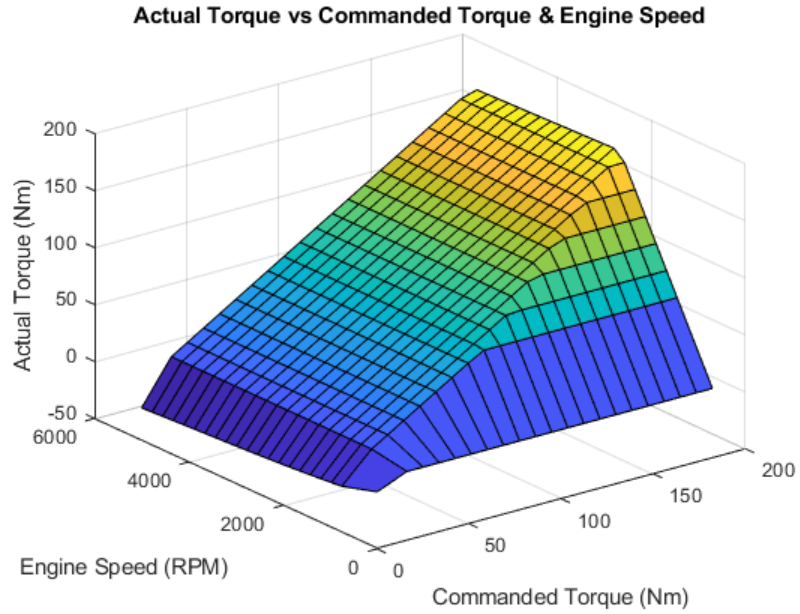

Maps generated from GT-POWER

Controls-oriented Model Creation

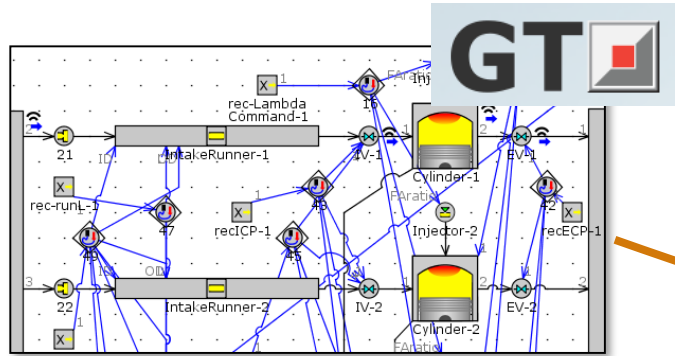

Detailed, design-oriented model

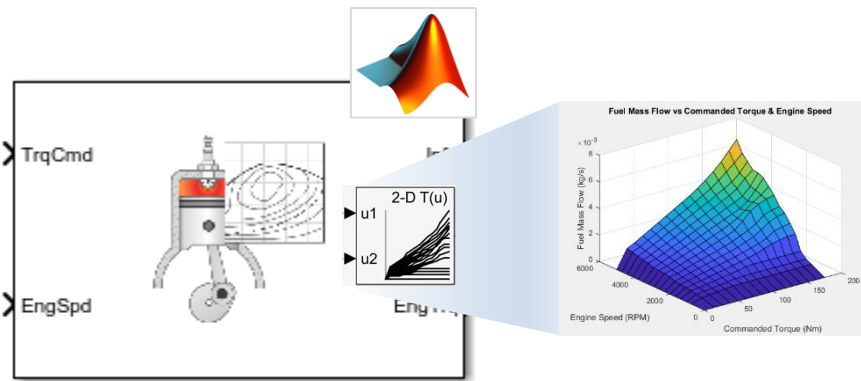
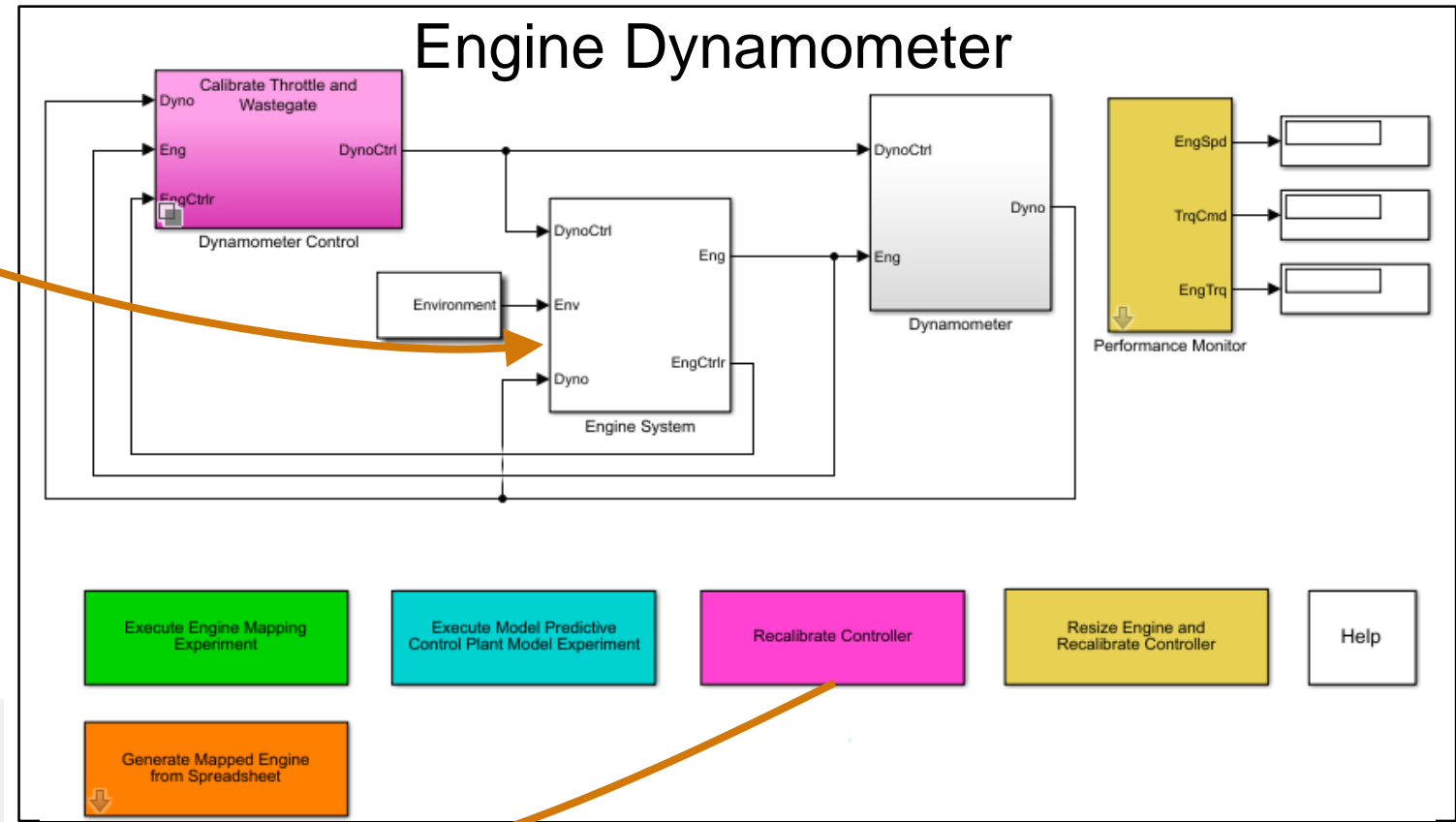

Fast, but accurate controls-oriented model

Plant Model: Electrical Subsystem

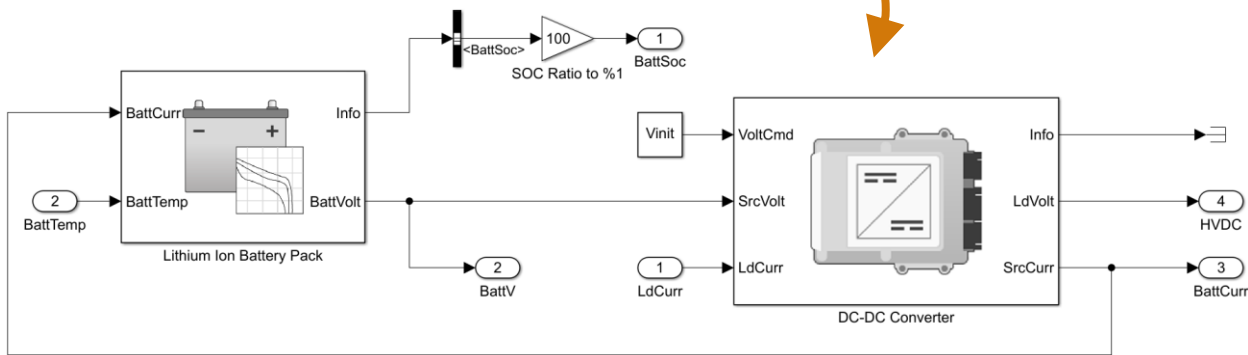
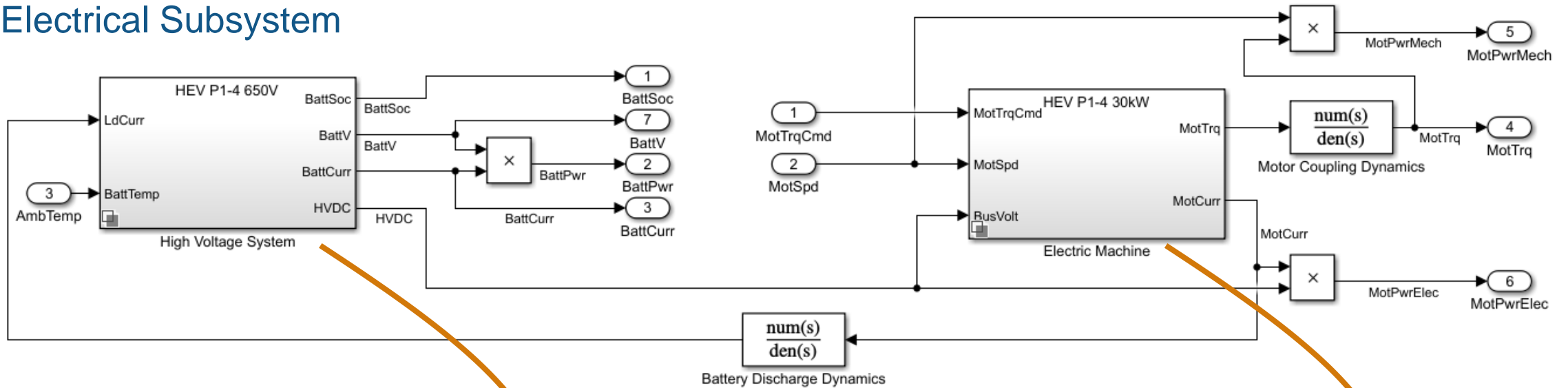

650 V Battery & DC-DC Converter
(smaller sizing for P0)

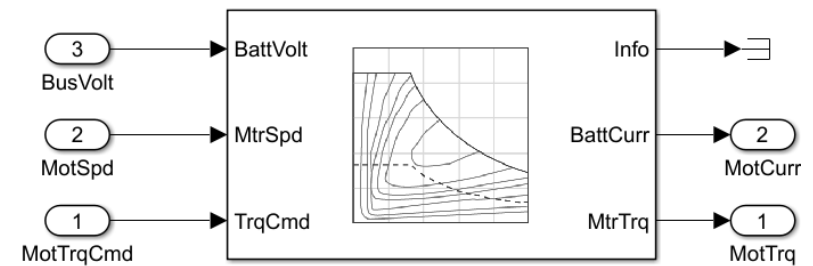

30 kW Motor
(10 kW for P0)

Plant Model: Driveline Subsystem

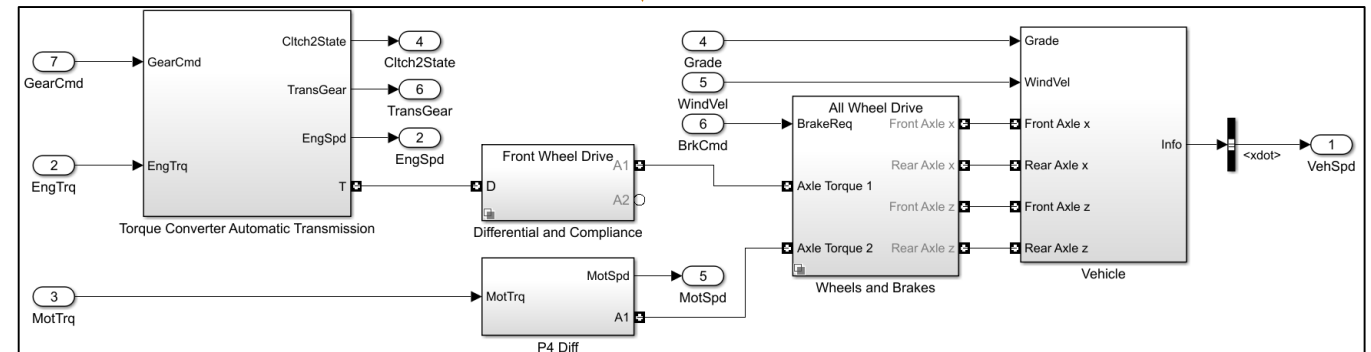
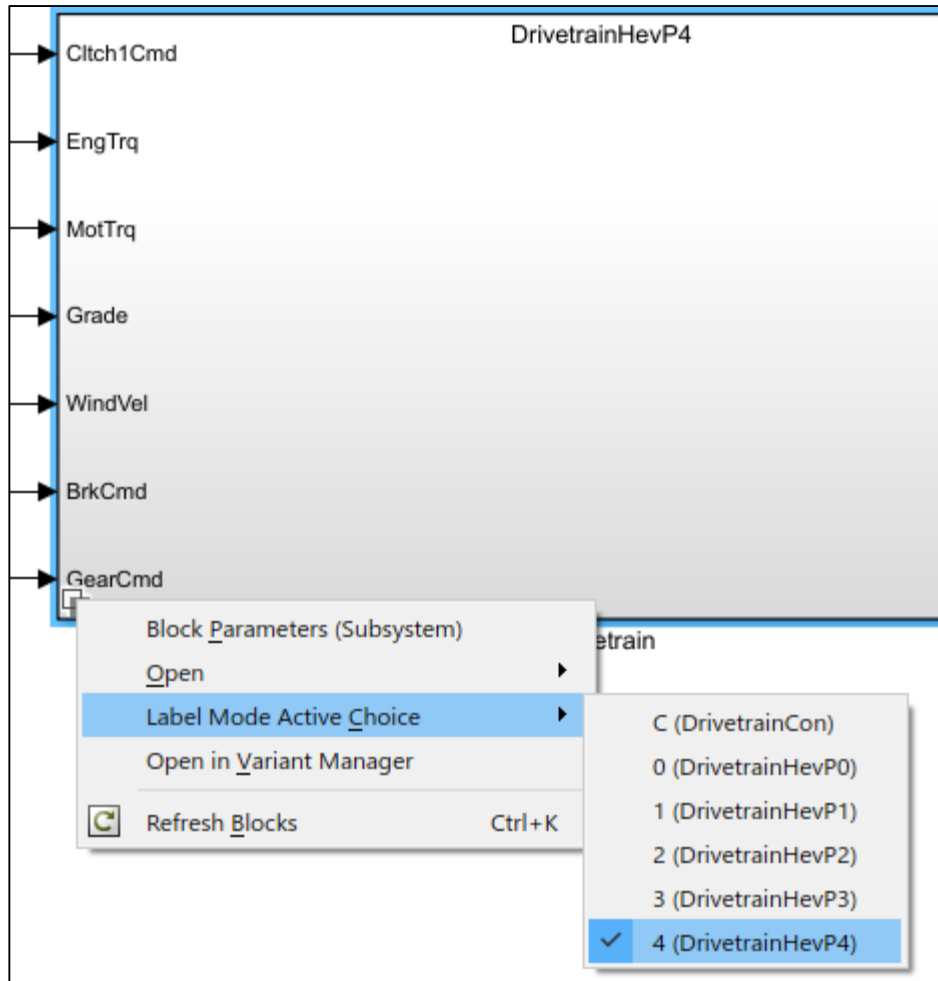

Controller: Hybrid Control Module

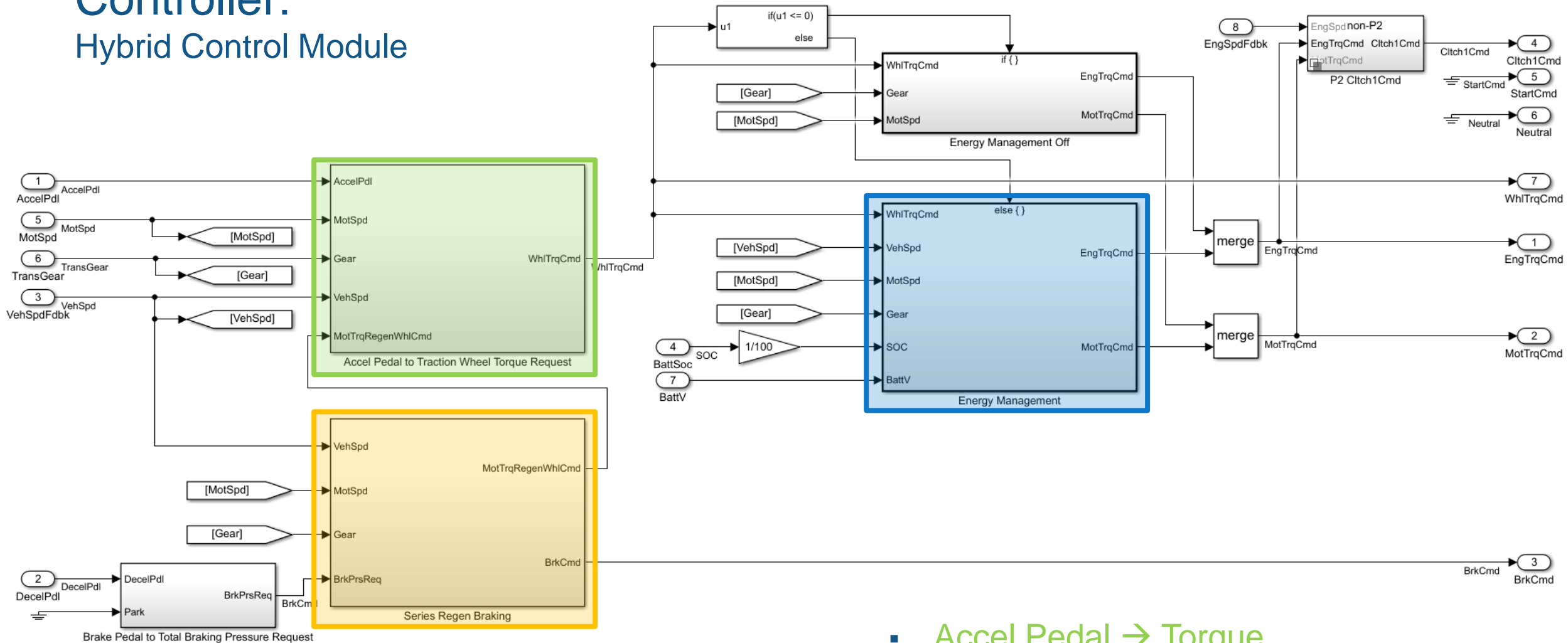

- Accel Pedal → Torque
- Regenerative Brake Blending
- Energy Management

Equivalent Consumption Minimization Strategy (ECMS)

- What is ECMS?
 - Supervisory control strategy to decide when to use engine, motor or both
 - Based on analytical instantaneous optimization
- Why use ECMS?
 - Provides near optimal control if drive cycle is known a priori
 - Can be enhanced with adaptive methods (i.e. Adaptive-ECMS)

$$\min P_{equivalent}(t) = P_{fuel}(t) + s(t) \cdot P_{battery}(t),$$

where $s(t)$ are the “equivalent factors”

Equivalent Consumption Minimization Strategy (ECMS)

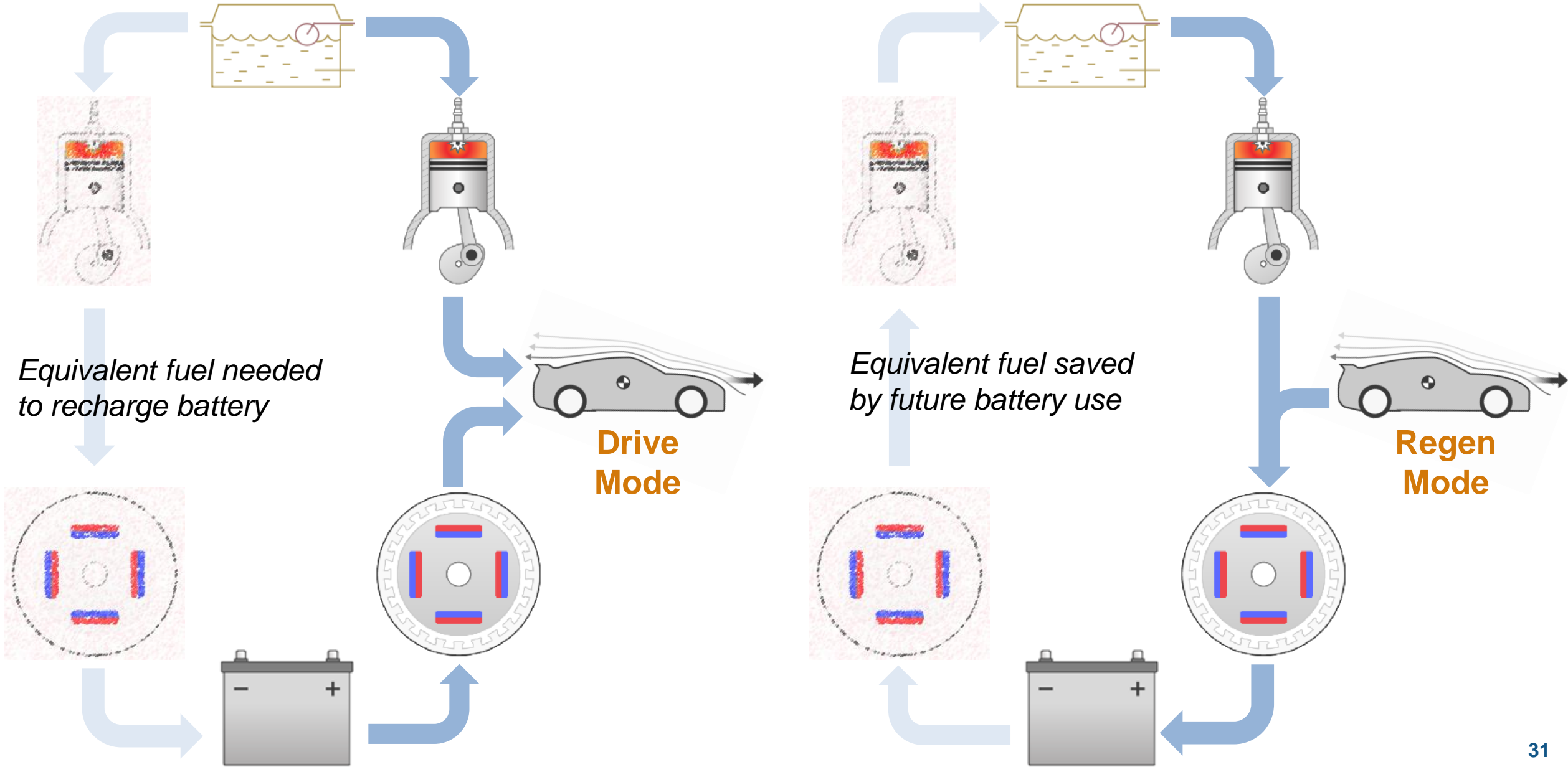

Equivalent Consumption Minimization Strategy (ECMS)

- Collaborated with Dr. Simona Onori from Stanford University
- For more information on ECMS, refer to:

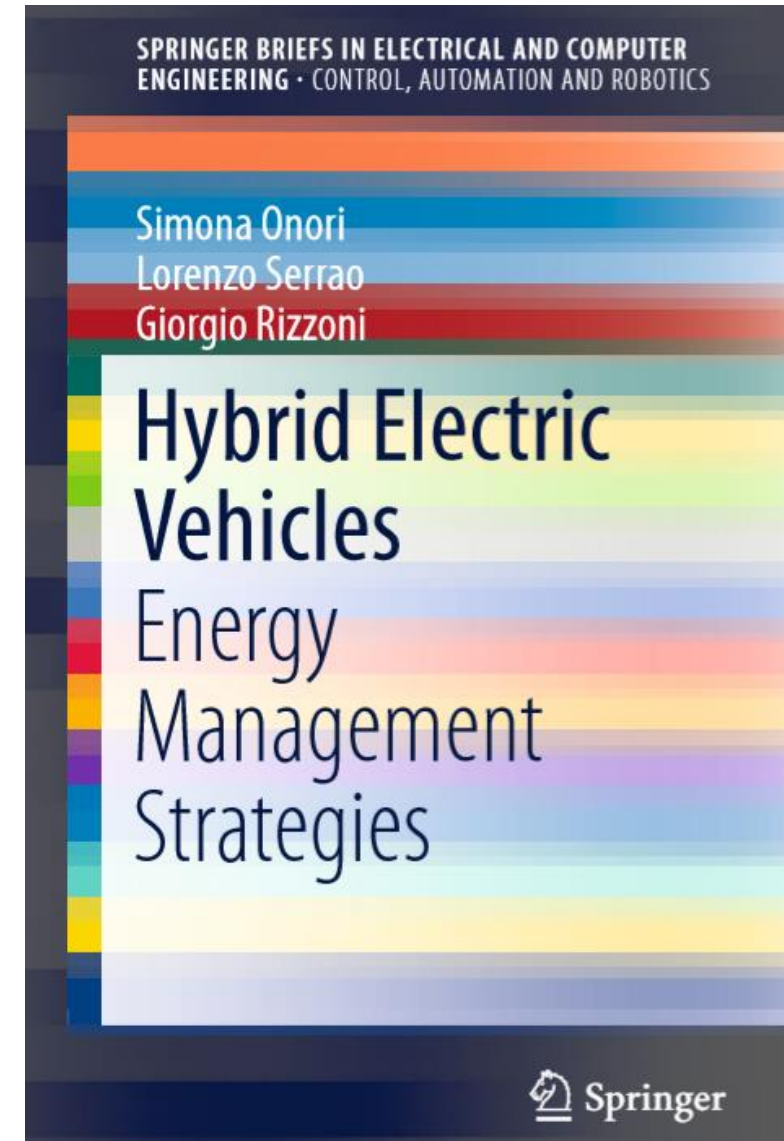

Agenda

- Context
- Case study description
- Tools used
- Plant model and controls
- Results
- Next steps

Methodology

- Generate Powertrain Blockset mapped engine from GT-POWER model
- For each P_i architecture:
 - Using mapped engine model, iterate on s (controller parameter) to achieve $dSOC \leq 1\%$ across each drive cycle
 - Assess fuel economy on city, highway and US06 drive cycles
 - Assess acceleration performance on Wide Open Throttle (WOT) test
- Compare fuel economy and performance across P0 – P4 architectures

Results

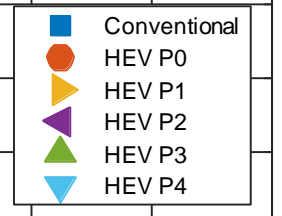
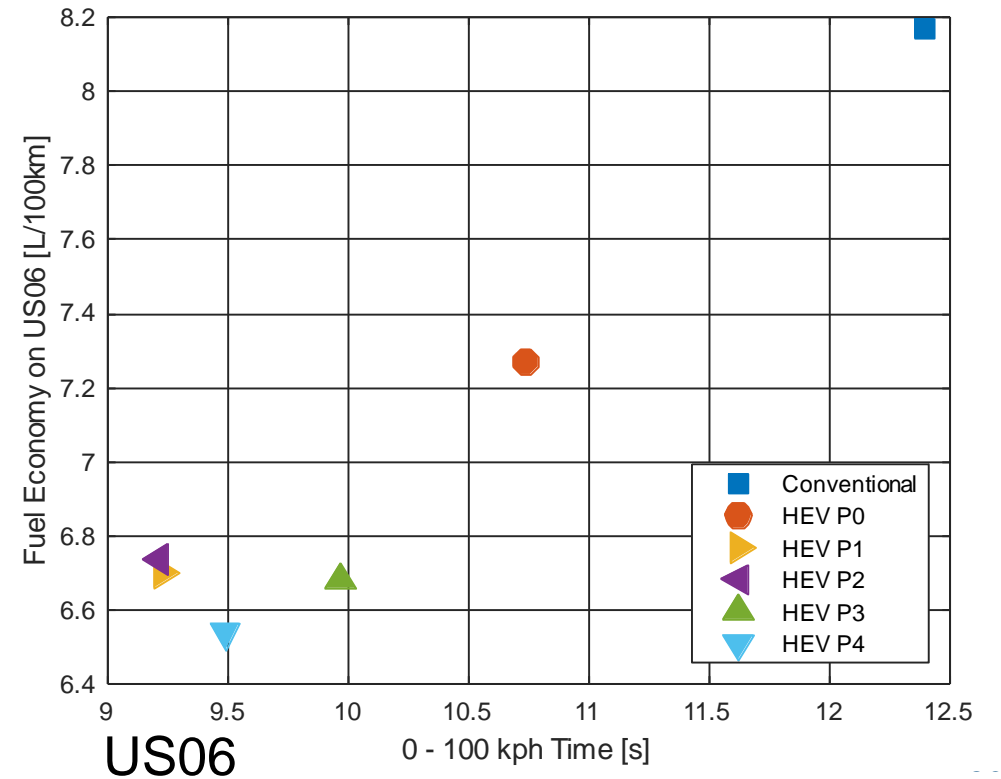
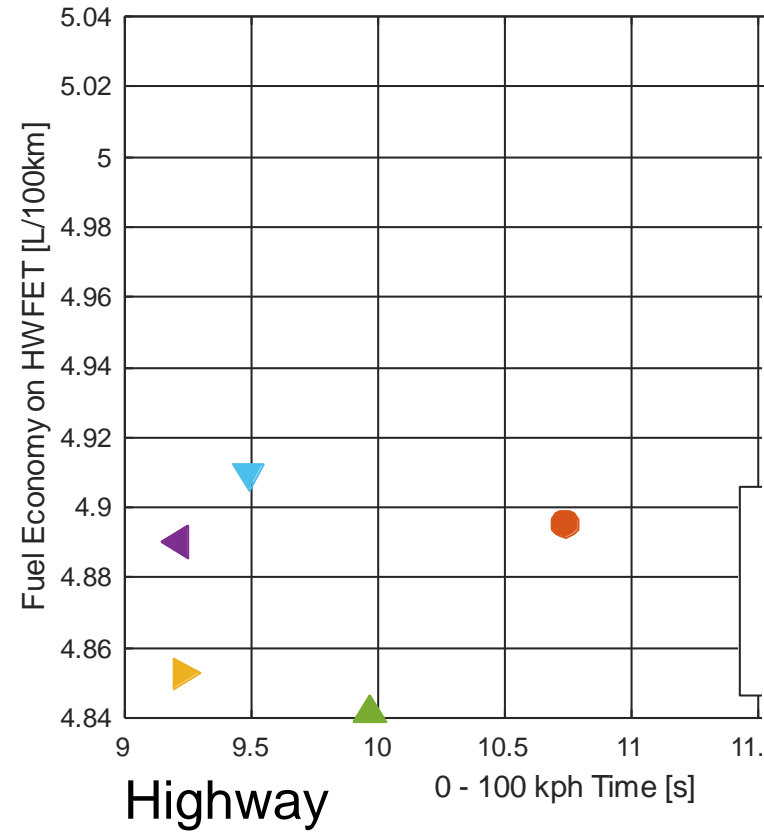
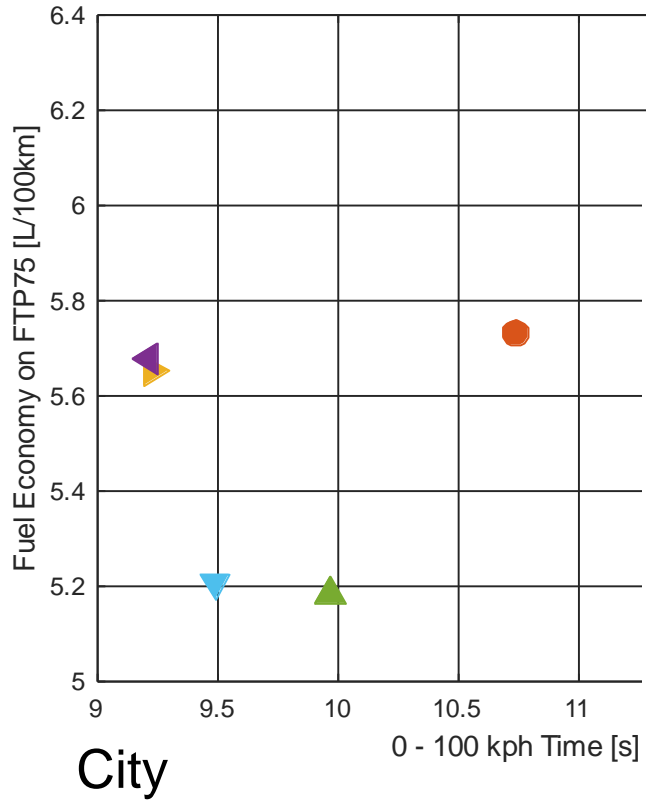

Results

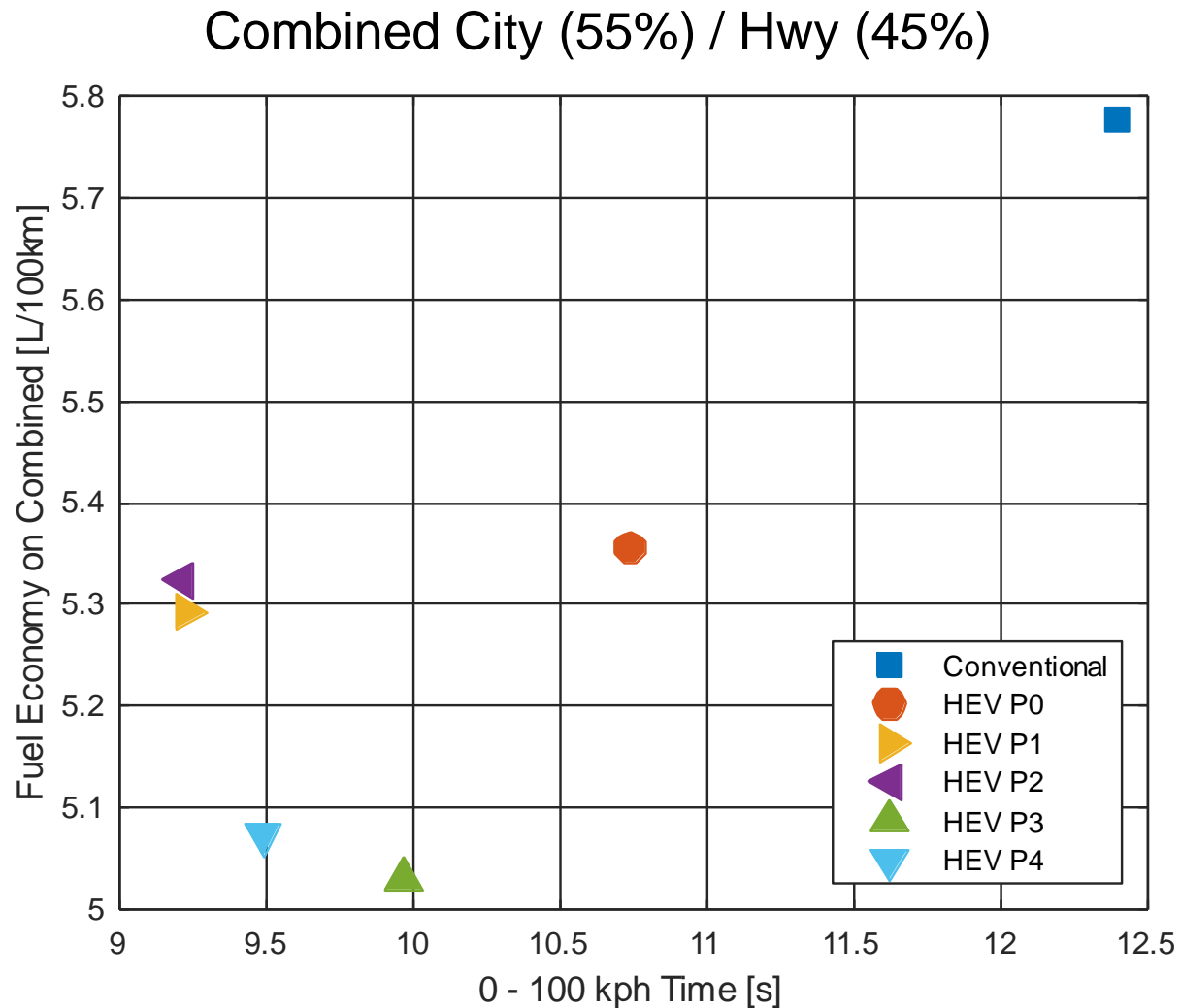

- ECMS provides a fair comparison of alternatives
- Placing motors closer to the drive wheel:
 - Improves fuel economy (better regen efficiency)
 - Degrades performance (lower mechanical advantage)
- Simulation allows you to quantify the tradeoff

Agenda

- Context
- Case study description
- Tools used
- Plant model and controls
- Results
- Next steps

Summary

- Assembled full vehicle simulation
 - Powertrain Blockset as framework for vehicle level modeling
 - Mapped engine models auto-generated from design-oriented engine model
 - ECMS for supervisory controls strategy applicable to all P0 – P4 variants

- Assessed fuel economy / performance across several variants
 - Iterated on controller parameter to identify charge neutral settings
 - Generated pareto curve to quantify tradeoff between variants

Next Steps

- Widen the scope of powertrain selection study
 - Include two-motor HEV's, with modified ECMS controls
 - Search over design parameters (final drive ratio, battery capacity, etc.)

- Conduct more in-depth analysis
 - Assess additional attributes of interest by including more design-oriented models (engine, aftertreatment, drivability, etc.)
 - Integrate control features from advanced development / production

- Continue along the V-cycle
 - Once field candidates are narrowed down to a few options, conduct more detailed electrification study (motor controls, battery design, etc.)
 - Once vehicle platform is selected, calibrate vehicle (drivability, etc.)

Thank You

Eva Pelster

Application Engineer

Eva.Pelster@mathworks.com