

Engine Plant Model Development and Controller Calibration using Powertrain Blockset™

Brad Hieb
Scott Furry

Application Engineering
Consulting Services

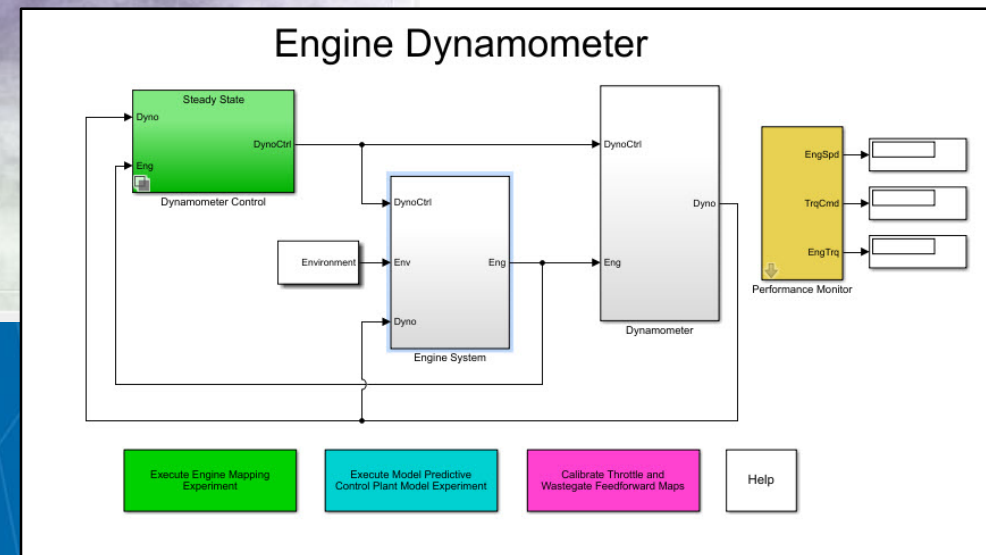
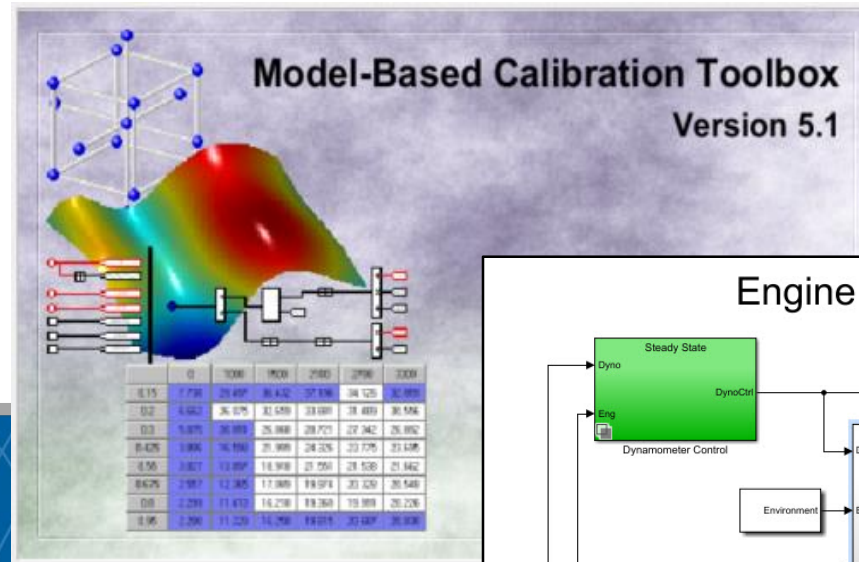

Key Take-Away's

- Engine model parameterization is a very non-trivial task
- Engine controller calibration is a very non-trivial task
- **MathWorks has tools to help make these two tasks more manageable**



Problem Statement

- How do I use the Powertrain Blockset engine and controller models for my application so I can:
 - Design engine controls?
 - Perform fuel economy and emissions studies?
 - Create and validate dynamometer test plans?

What we'll Cover Today

- Parameterizing a Powertrain Blockset engine model
 - Workflow
 - Example: parameterizing a mapped engine model

- Calibrating a Powertrain Blockset engine controller
 - Workflow
 - Example: calibrating an engine controller

What are we Parameterizing and Calibrating?

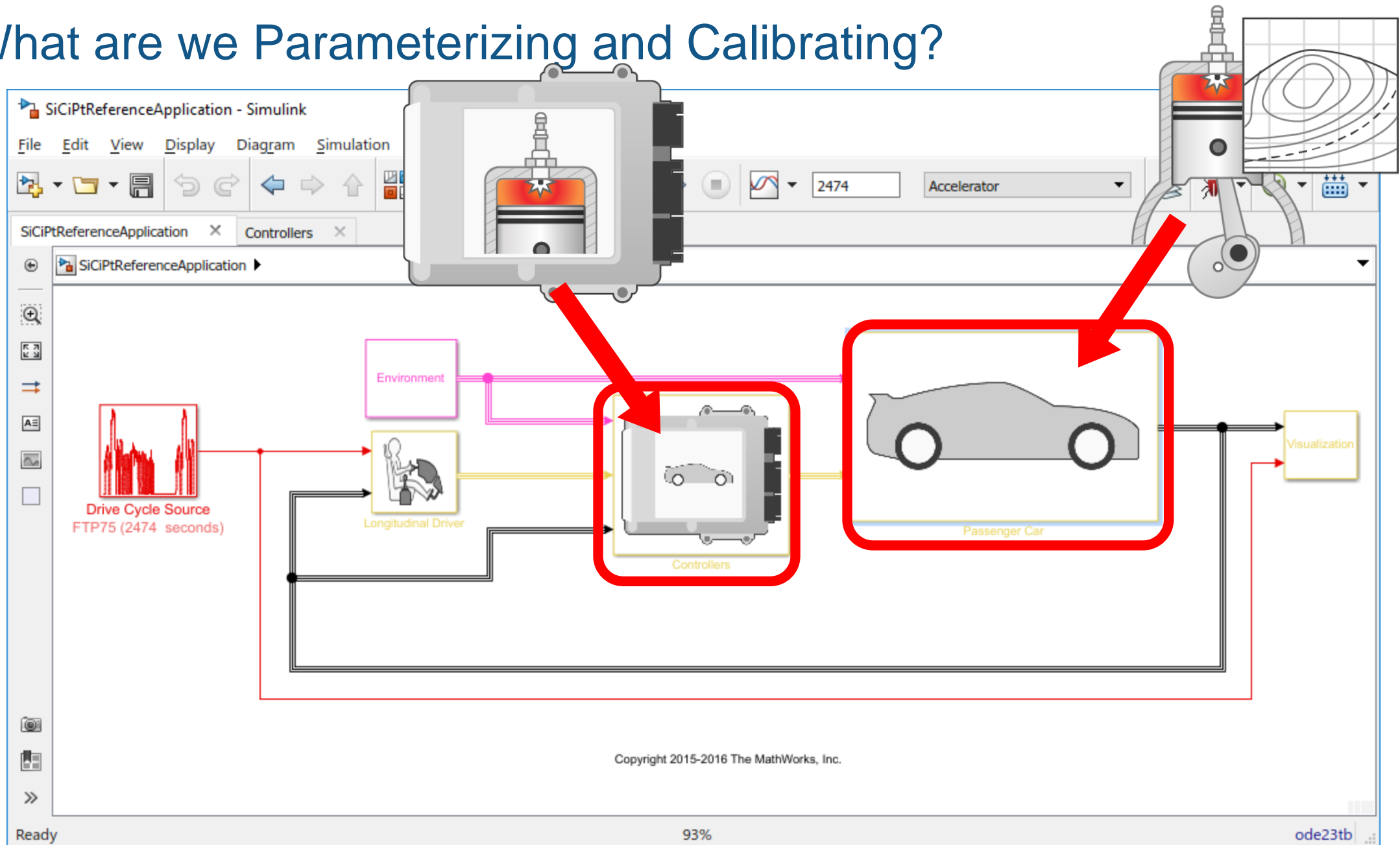

Copyright 2015-2016 The MathWorks, Inc.

What we'll Cover Today

- **Parameterizing a Powertrain Blockset engine model**
 - Workflow
 - **Example: parameterizing a mapped engine model**
- Calibrating a Powertrain Blockset engine controller
 - Workflow
 - Example: calibrating an engine controller

Powertrain Blockset Si Mapped Engine Model

- Contains 2D LUT's for each model output
- Easy to parameterize
- Great for system level design and development

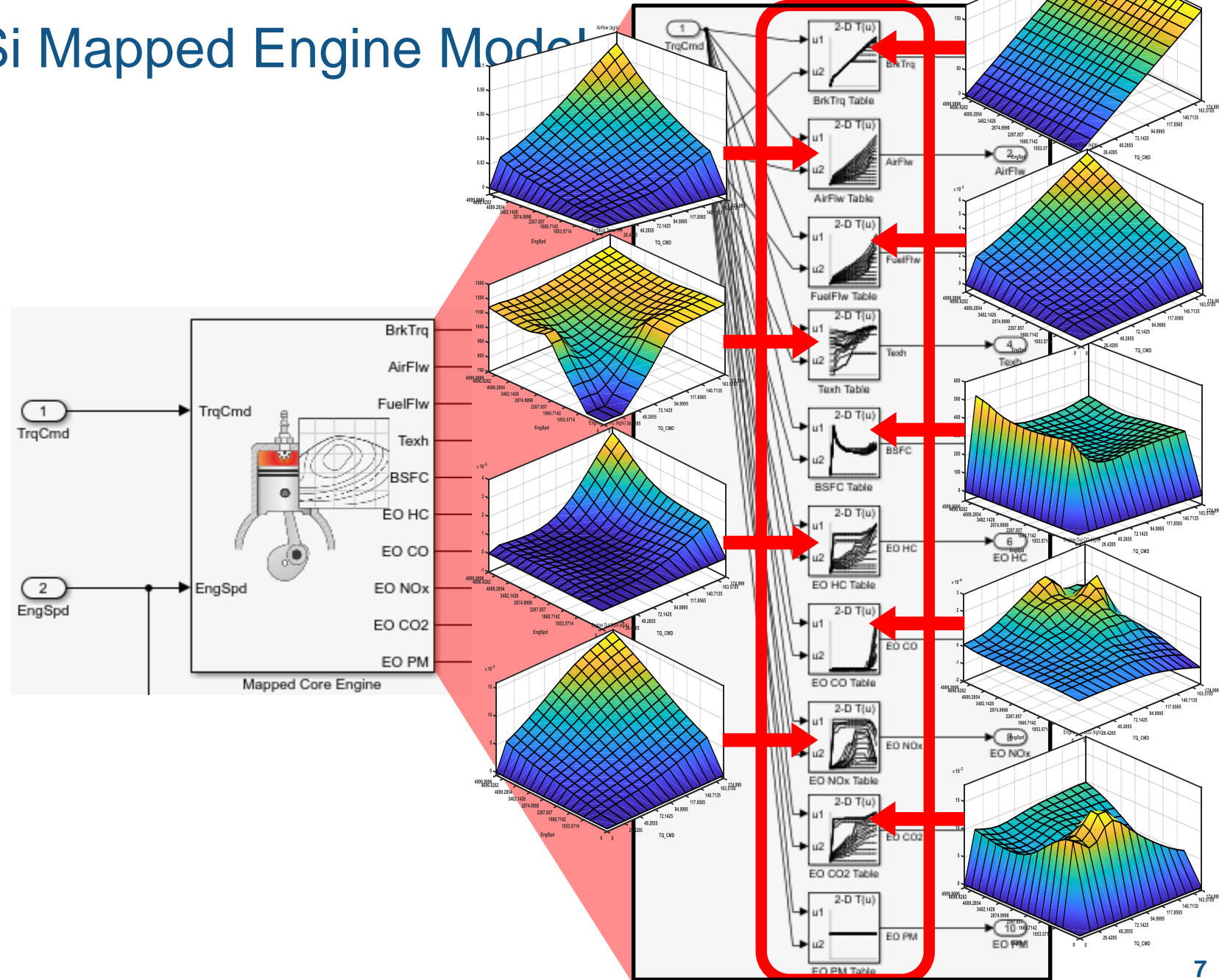

Parameterizing an Engine Model

- Workflow

- Model-Based Calibration Toolbox provides tools for the process:
 - Creating the Design of Experiments**

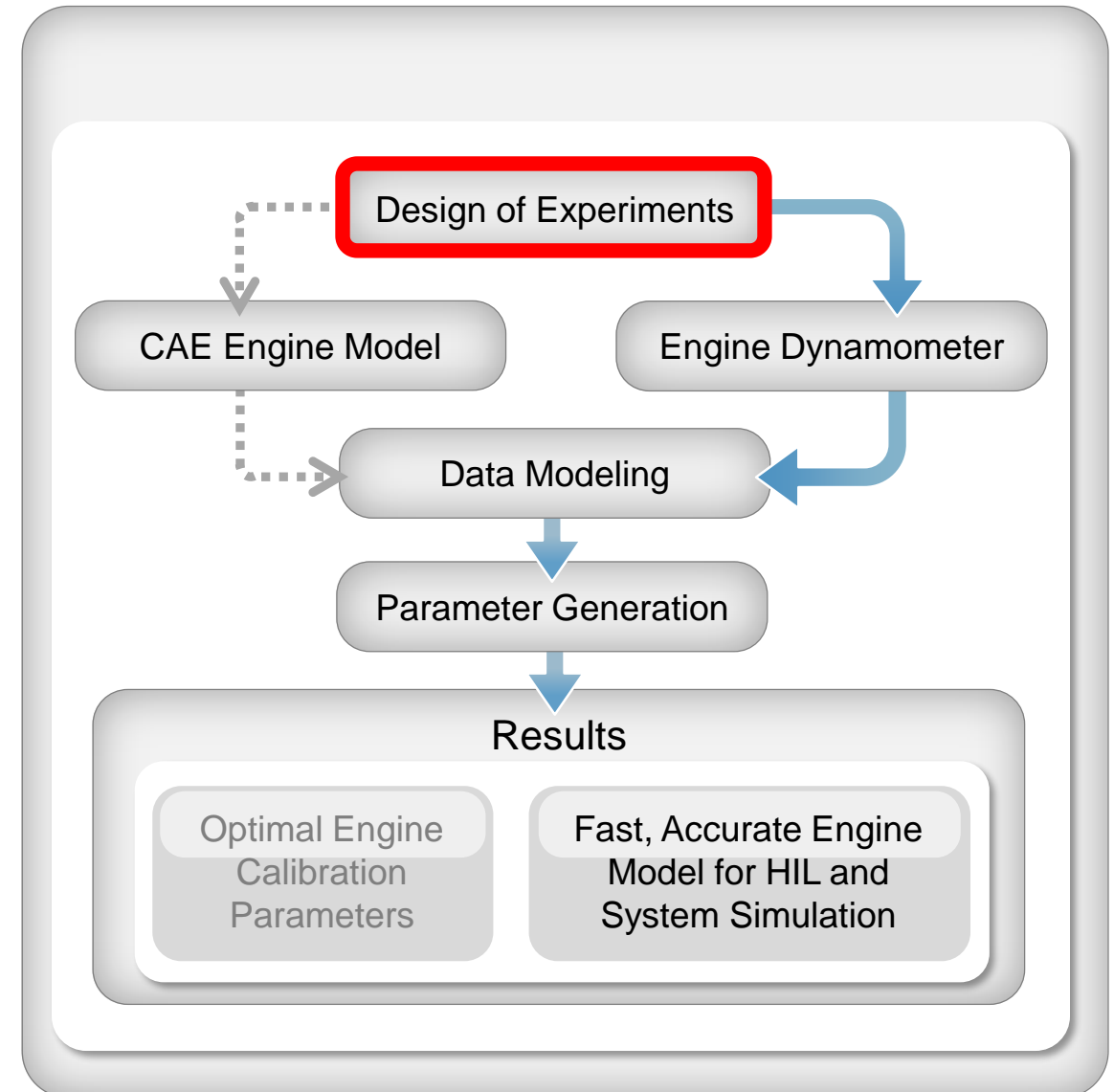

Parameterizing an Engine Model

- Workflow

- Model-Based Calibration Toolbox provides tools for the process:
 - Creating the Design of Experiments
 - Gather the data**

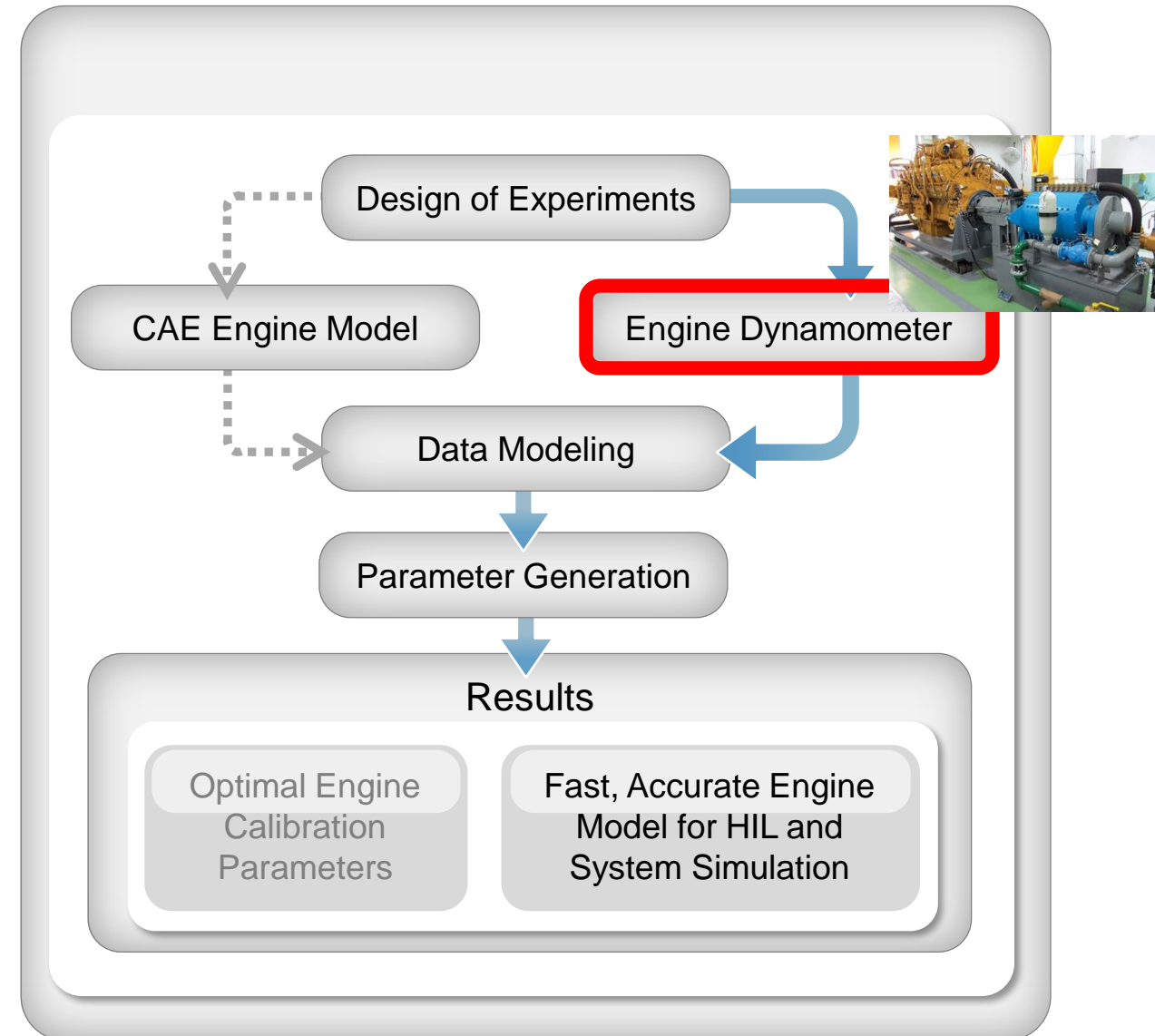

Parameterizing an Engine Model

- Get the data “as calibrated”

- Measurements**
- Air Flow
 - Fuel Flow
 - Exhaust Temp
 - Emissions
 - BSFC

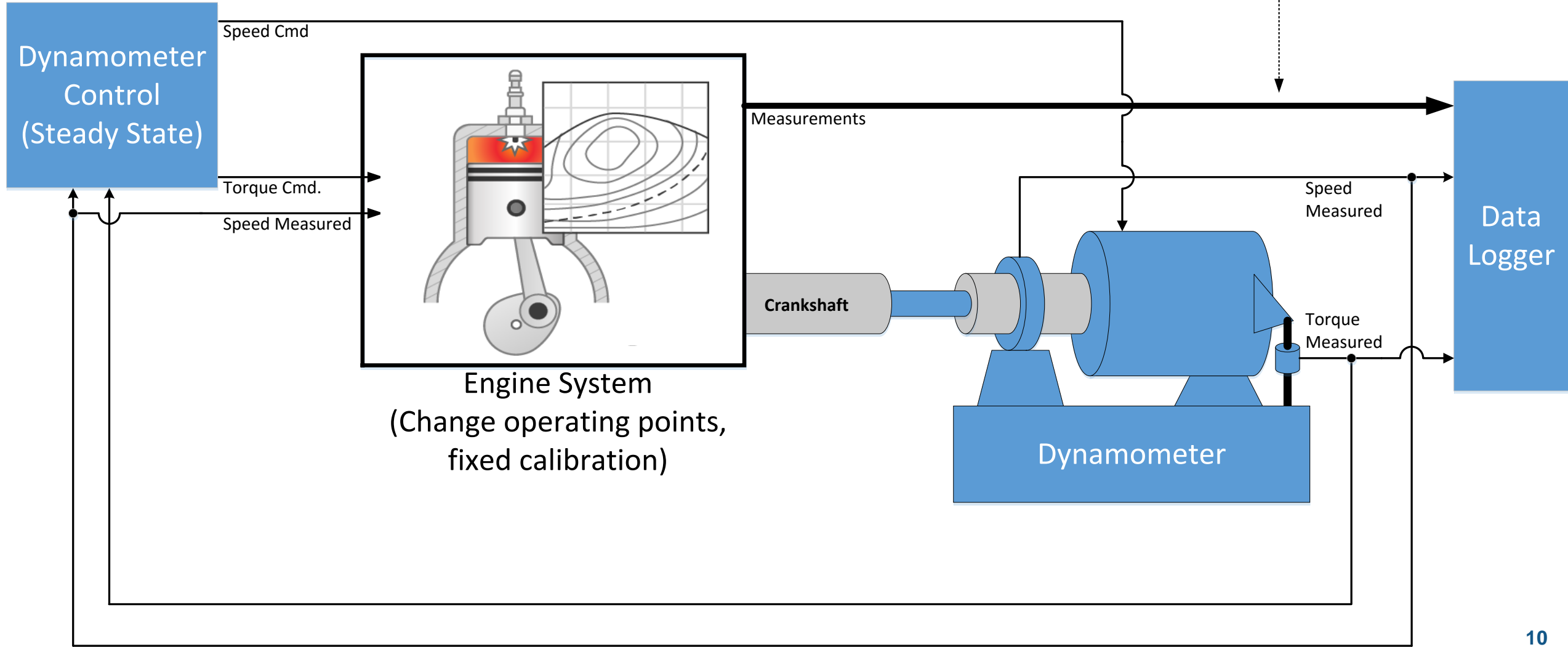

Parameterizing an Engine Model

- Workflow

- Model-Based Calibration Toolbox provides tools for the process:
 - Creating the Design of Experiments
 - Gather the data
 - **Fitting response surface models (RSM, statistical) to the data**

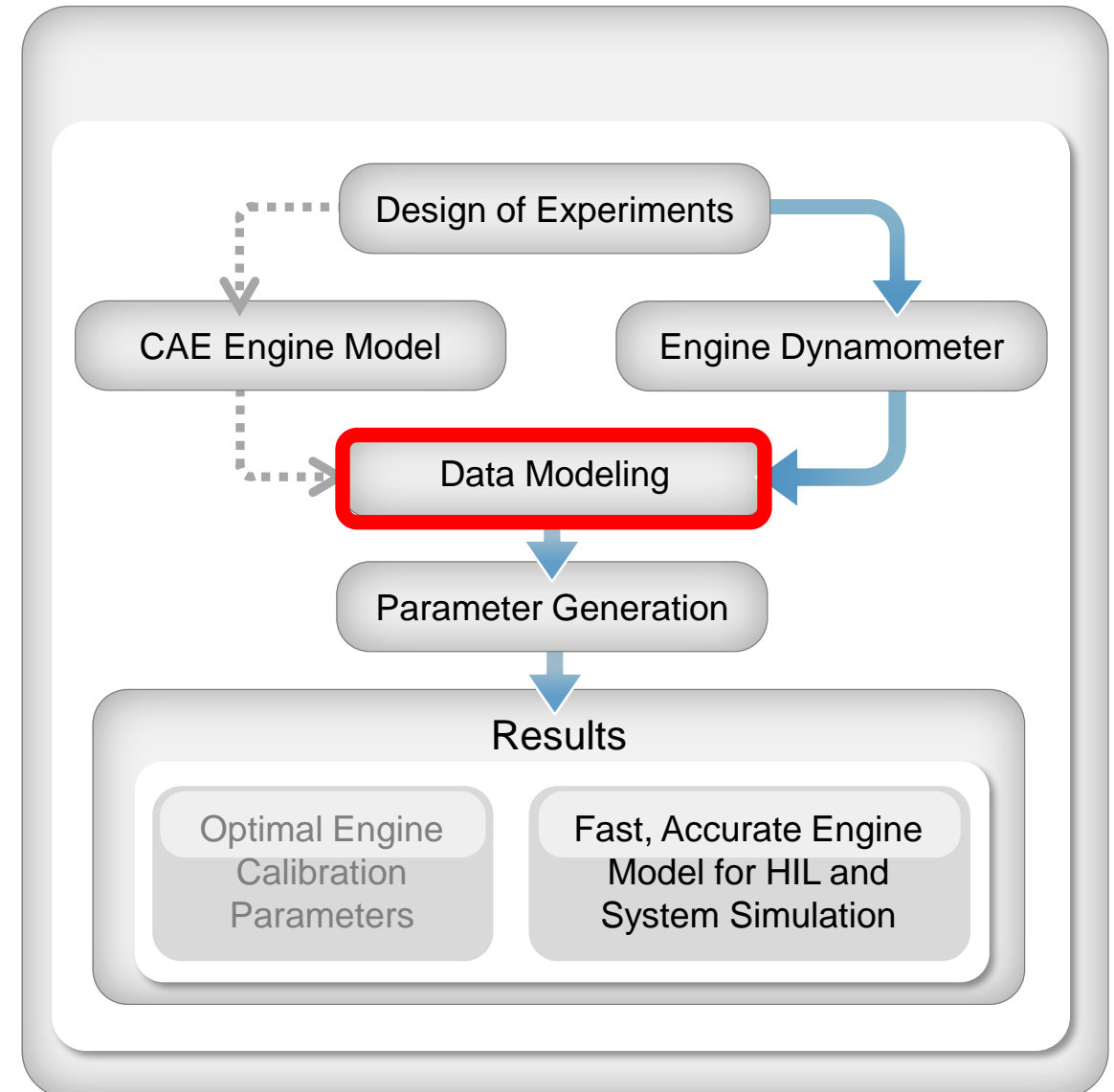

Parameterizing an Engine Model

- Workflow

- Model-Based Calibration Toolbox provides tools for the process:
 - Creating the Design of Experiments
 - Gather the data
 - Fitting response surface models
 - **Developing engine performance maps from RSM's**

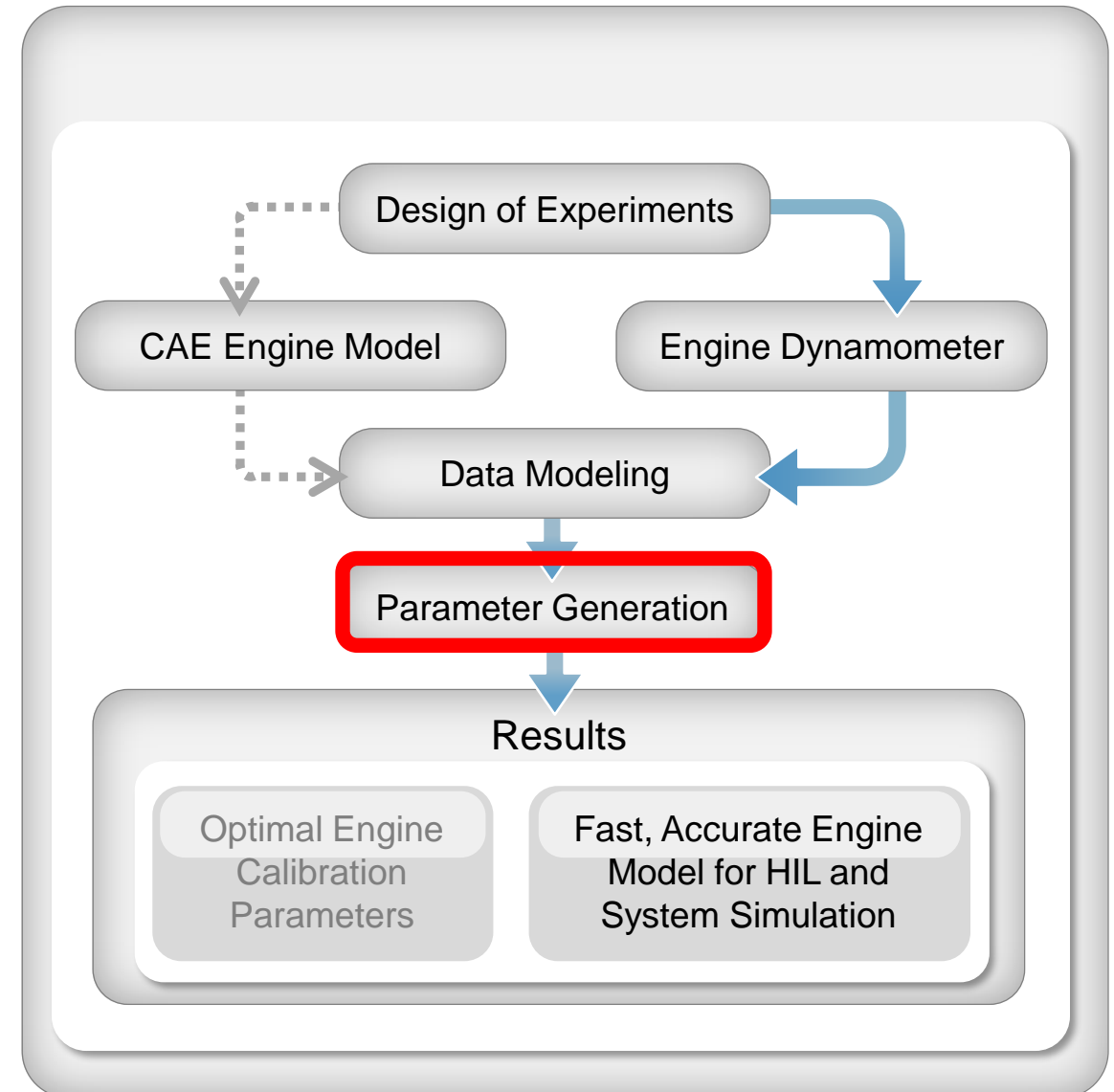

Parameterizing an Engine Model

- Workflow

- Model-Based Calibration Toolbox provides tools for the process:
 - Creating the Design of Experiments
 - Gather the data
 - Fitting response surface models
 - Developing engine performance maps
 - **Validate the result**

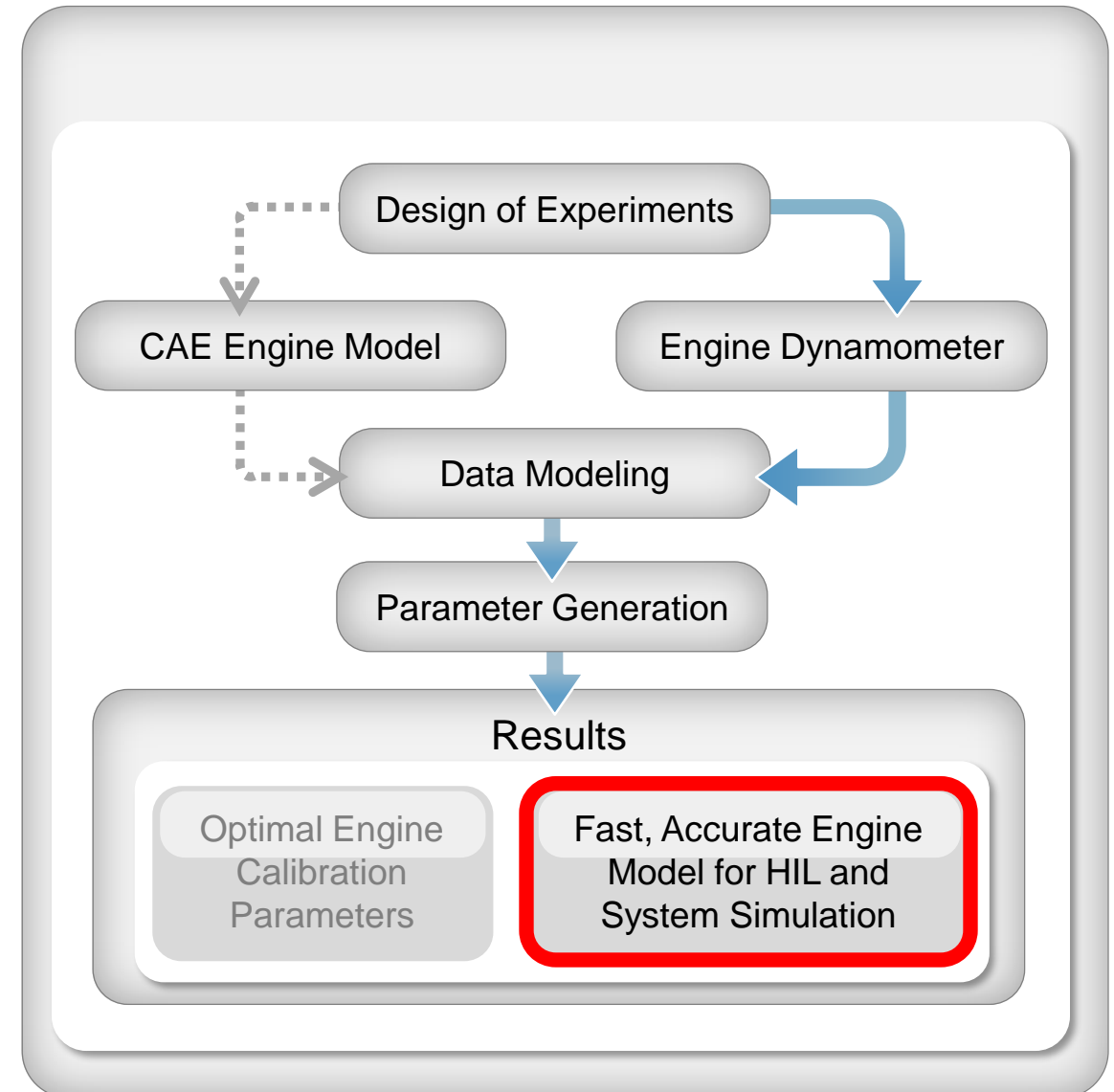

Launch MBC Toolbox

- From Apps tab
- From command line
`>> mbcmodel`

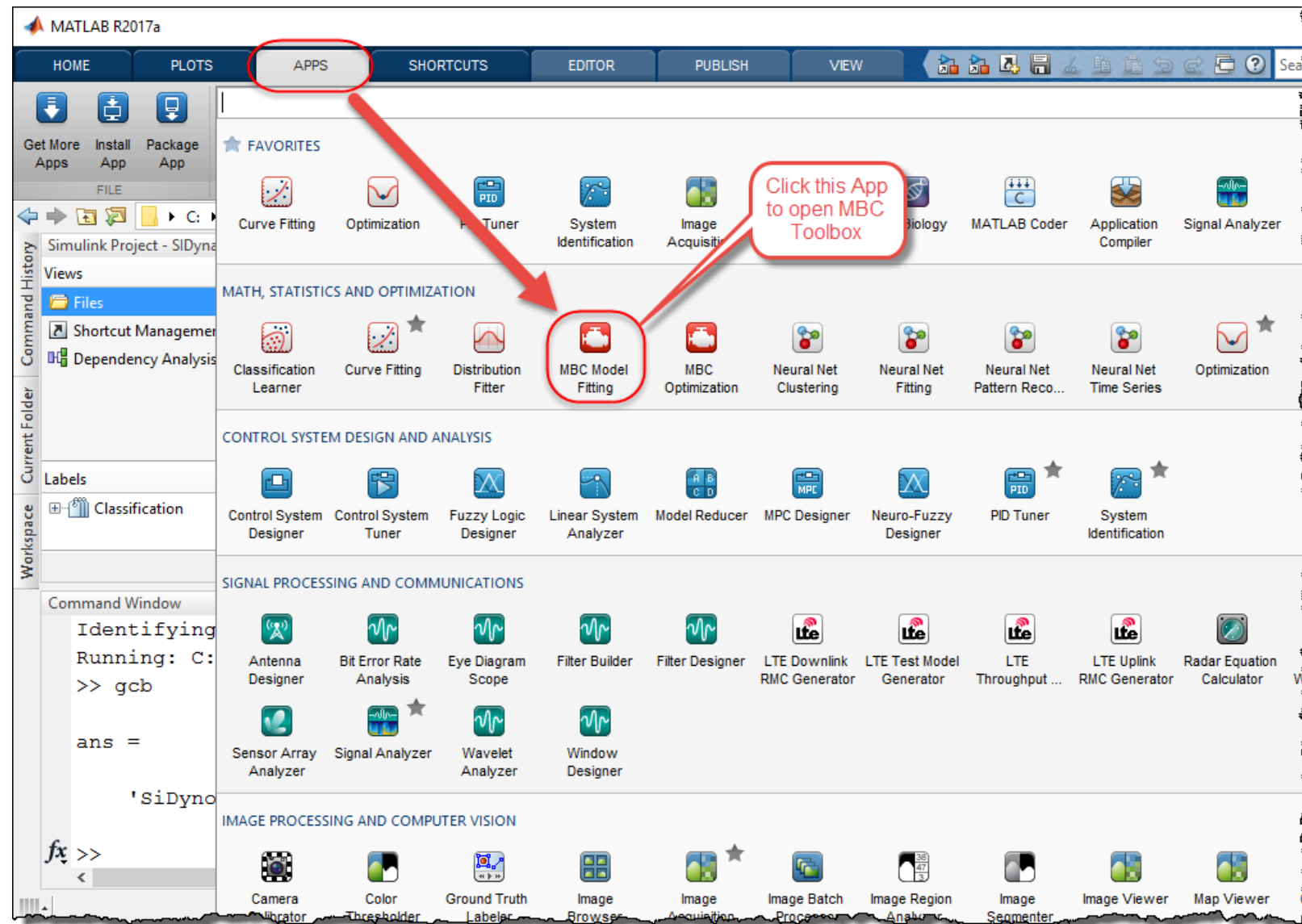

Launch MBC Toolbox

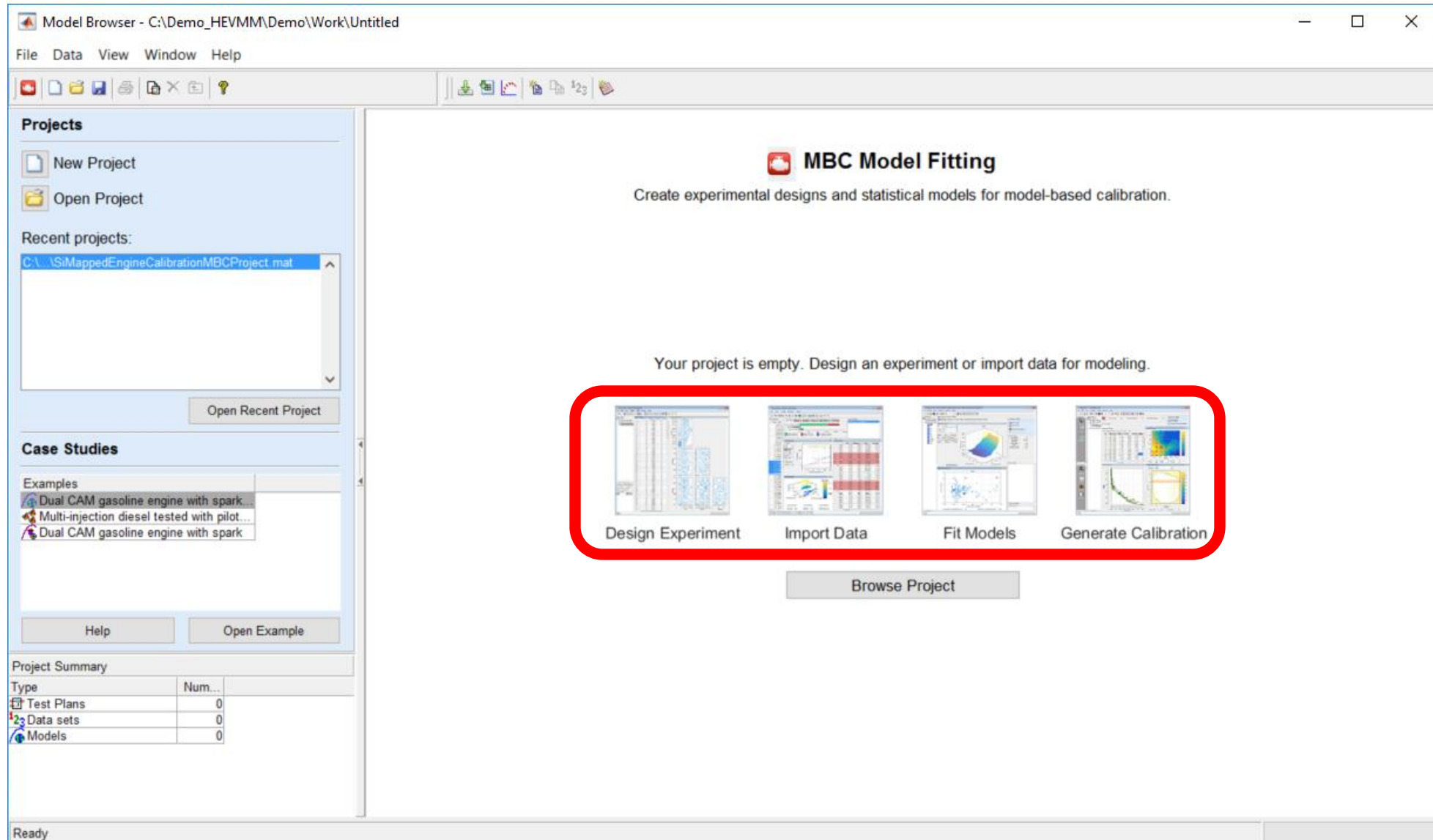

Parameterizing a Mapped Engine Model

- Importing existing data

- Mapped engine model workflow:

- Importing existing data

NO.	RPM	Torque	MAT	AIRFLOW	IRD	SplAdv	Lam	ICP	ECP	TAP	WAP	Torque	TorqueOv	Constrain	BMEP	RF1	KIT1
1	650	45	50.92366	8.973919	41	7.45	1	0	0.02773	100	45.11553	45	1	3.785236	13.03376	0.705455	
2	700	25	53.01297	2.847983	41	14.3	1	0	0.63428	100	24.99674	25	1	2.084415	18.20444	0.371948	
3	700	50	55.03702	4.519683	41	10.25	1	14	14	1.083356	100	49.98001	50	4	4.10591	20.02891	0.77236
4	750	25	52.72737	1.025519	41	15.3	1	0	0.67528	100	25.00004	25	1	2.083347	17.63783	0.35643	
5	750	35	51.52888	3.70346	41	11.95	1	0	0.844225	100	34.99955	35	1	2.516664	14.62979	0.499917	
6	750	70	48.65538	6.443255	41	0	1	20	46	70.30754	100	67.454	43.61479	0	5.837343	17.6074	1.141213
7	800	30	54.82476	1.621115	41	12.3	1	5	11	0.792186	100	29.9888	30	0	2.491156	20.00517	0.38084
8	800	40	53.19464	4.721616	41	0	1	33	42	69.70601	100	59.50613	51.10016	0	5.13104	20.0435	1.096666
9	800	45	49.99418	4.750452	41	11.3	1	0	1.099642	100	45.00372	45	1	3.750286	12.20808	0.624516	
10	800	65	48.25568	6.283071	41	10	1	6	2	1.654519	100	65.00113	65	1	5.416523	20.45264	0.978133
11	850	15	53.70352	2.647666	41	14.55	1	0	0.590014	100	15.00794	15	0	1.250649	20.05847	0.191236	
12	850	20	52.95077	2.98217	41	19.45	1	0	0.660596	100	19.99251	20	1	1.660598	18.78677	0.278064	
13	850	35	51.84213	4.266449	41	13.8	1	0	0.940252	100	35.01695	35	1	2.567748	15.93502	0.462528	
14	850	85	58.42198	7.359644	41	0	1	48	33	69.85444	100	60.0294	58.95578	0	5.047529	20.99704	0.973099
15	900	20	72.70905	1.664539	41	50	1	25	23	8.825493	100	20.03939	20	0	1.670543	40.49988	0.602126
16	900	50	50.15692	5.701161	41	12.4	1	0	1.322963	100	49.98401	50	1	4.166411	10.97351	0.652149	
17	950	40	49.36214	5.090178	41	14.75	1	0	1.148058	100	40.02629	40	1	3.332051	12.3395	0.50113	
18	950	90	47.71186	4.425454	41	0	1	18	8	3.541745	100	80.97912	80.65272	0	6.748281	9.212198	0.944807
21	1000	30	51.15937	4.400513	41	17.6	1	0	0.984414	100	30.00003	30	1	2.49998	14.27896	0.370643	
22	1000	70	56.59245	8.234204	41	11.2	1	28	26	3.093745	100	69.99997	70	0	5.833319	20.05458	0.965194
23	1050	20	52.93079	1.629747	41	22.4	1	0	0.61212	100	20.00596	20	1	1.67129	17.21889	0.25292	
24	1050	30	50.95374	4.598652	41	18.4	1	0	1.031417	100	29.98478	30	1	2.49423	14.02174	0.357092	
25	1050	35	54.99617	5.027401	41	20.45	1	17	1.10885	100	35.01015	35	1	2.916622	18.38176	0.444375	
26	1050	95	45.60888	10.79042	41	0	1	22	33	73.5	61.21263	82.93326	83.15393	0	6.90889	10.91496	0.995224
27	1100	70	73.881	5.509662	41	50	1	15	35	1.604493	100	24.81467	25	0	2.65676	41.36849	0.644187
28	1100	25	53.30132	4.288941	41	21.1	1	0	0.946533	100	24.98494	25	1	2.080696	15.20741	0.301732	
29	1100	45	48.84553	6.312019	41	16.5	1	0	1.432047	100	44.97535	45	1	3.745336	10.99736	0.519056	
30	1100	48	47.66068	4.819454	41	11.45	1	15	30	3.713437	100	48.00000	48	0	6.648814	13.99946	0.893079

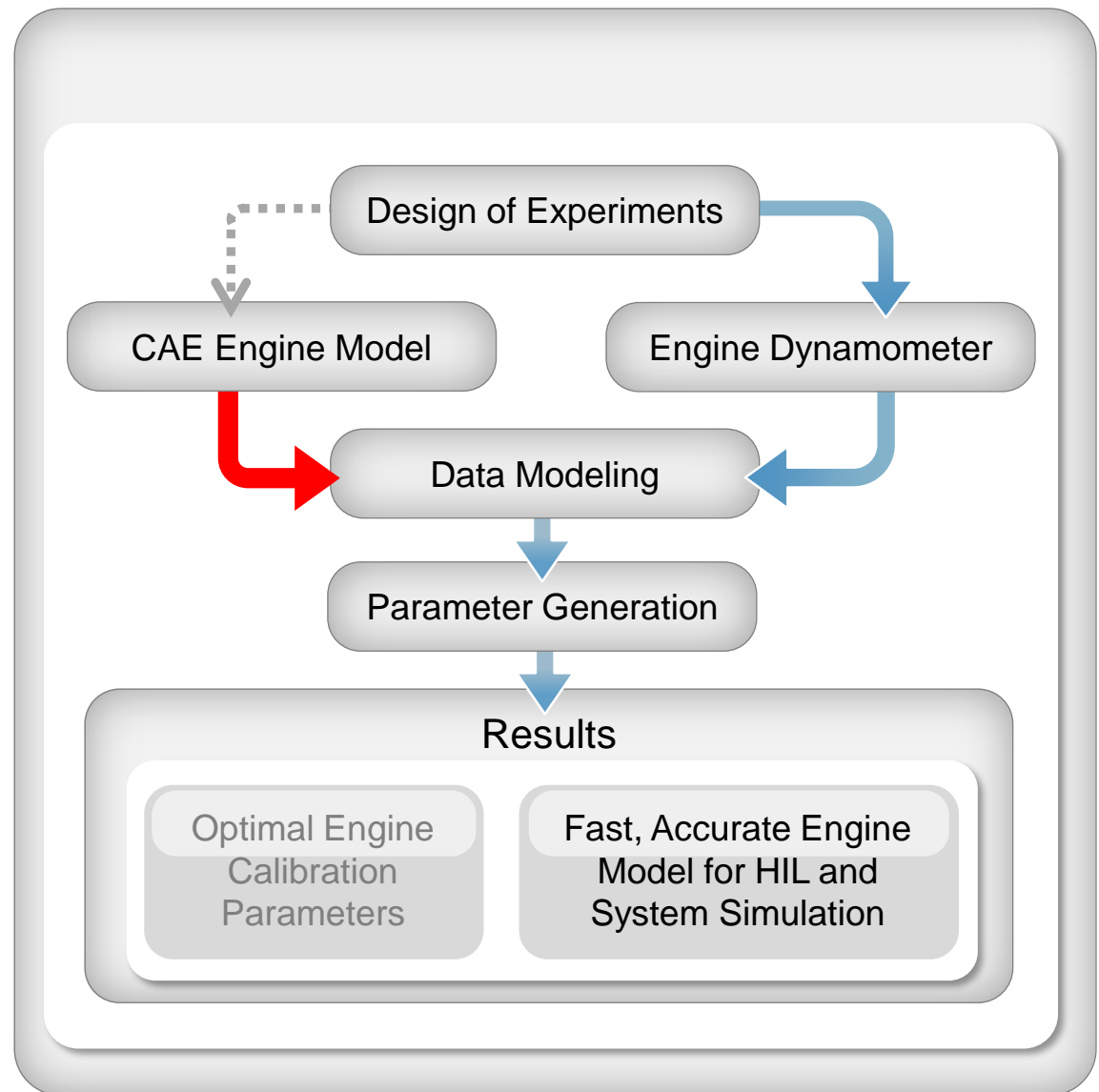

Import Data

- Inspect the data

- Look for anomalies or gaps
- Filter data to remove anomalies
- Add derived quantities and unit conversions
- Graphical views speed inspection

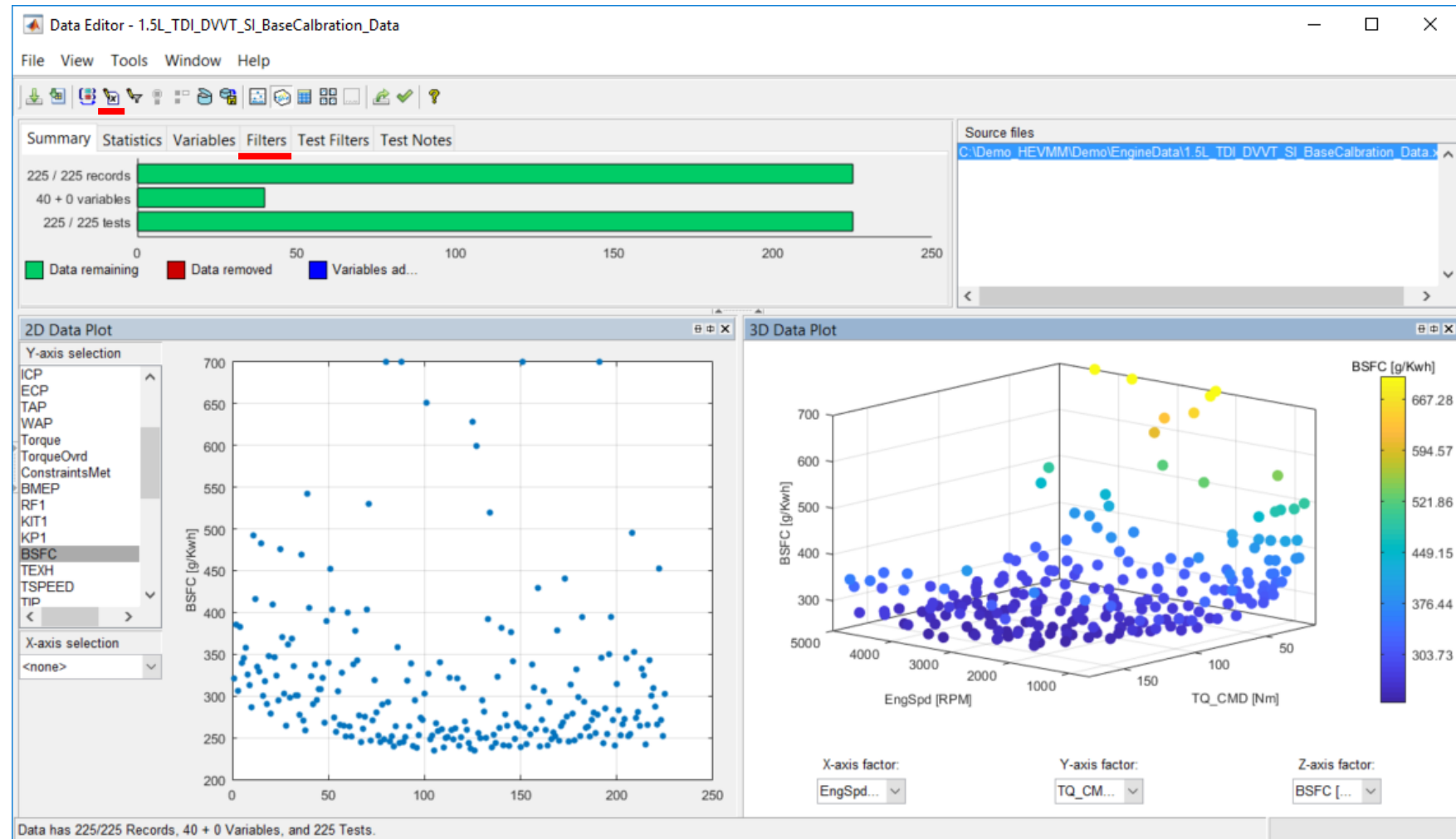

Parameterizing a Mapped Engine Model

- Fitting response surface models

- Mapped engine model workflow:
 - Importing existing data
 - **Fitting response surface models (RSM, statistical) to the data**

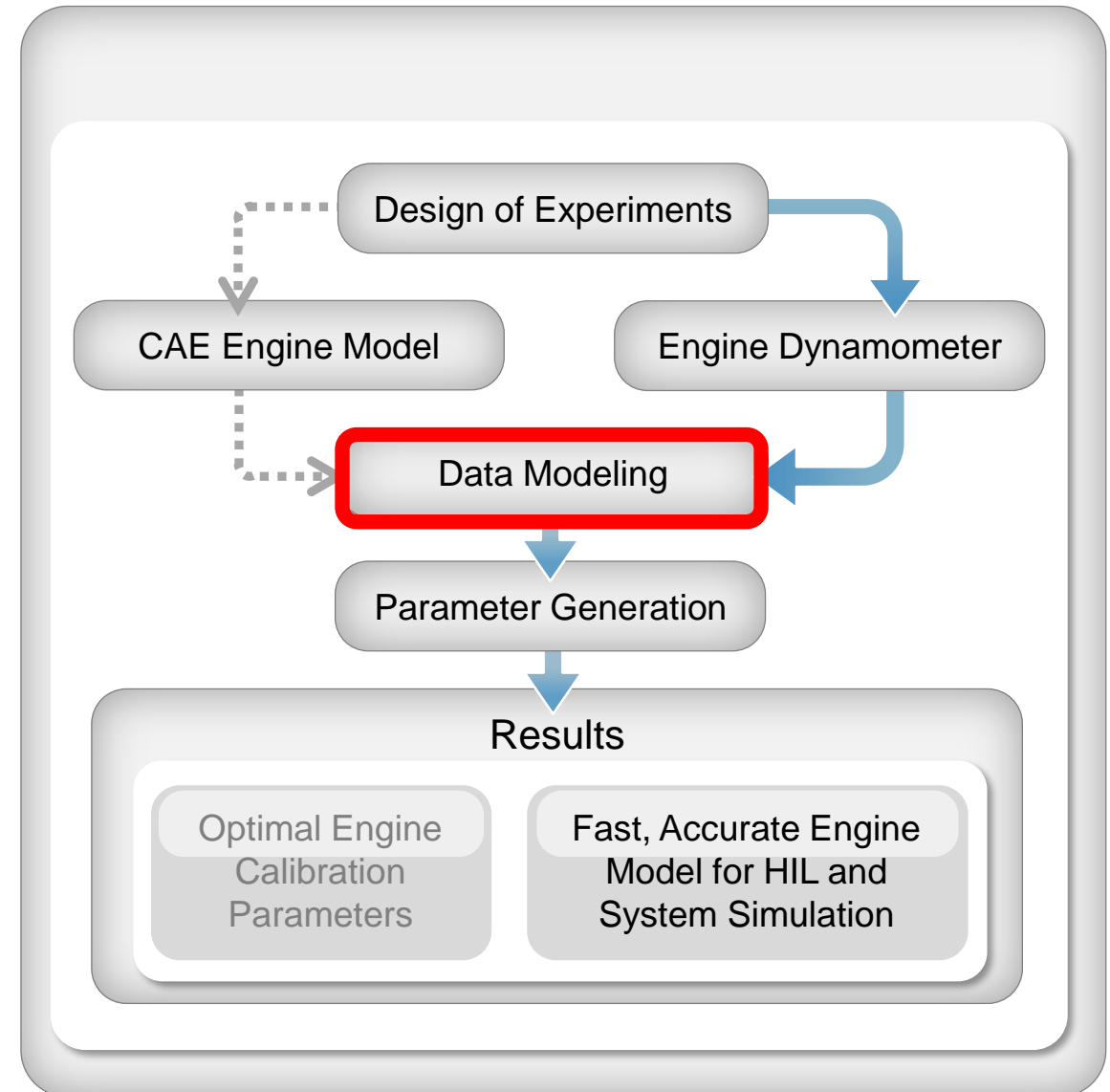

Fitting Models to the Data

- Generate response surface models

- Default models automatically fitted to all responses
- Inspect quality of fit
- Try out alternatives

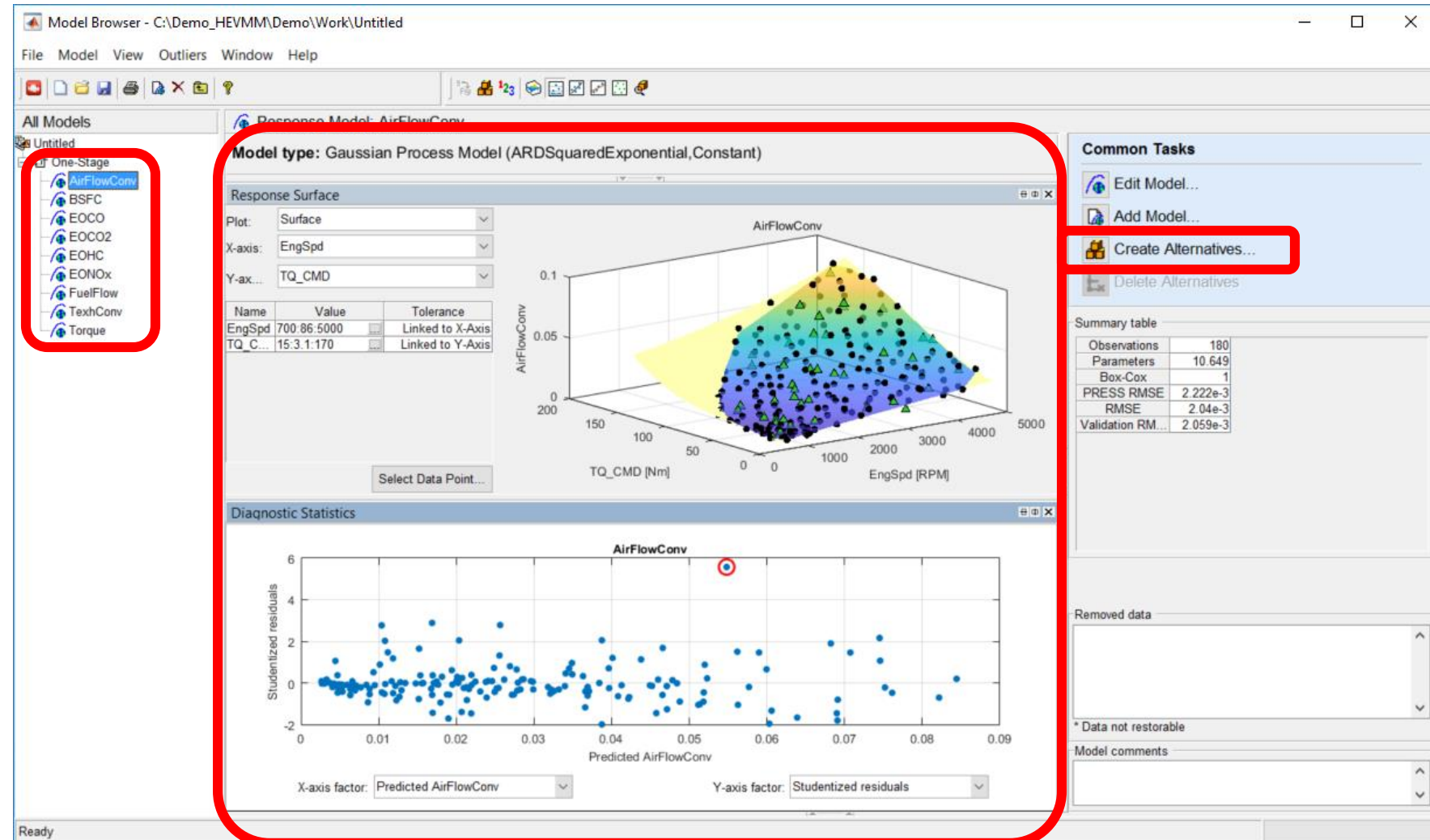

Parameterizing a Mapped Engine Model

- Developing engine performance maps

- Mapped engine model workflow:
 - Importing existing data
 - Fitting response surface models
 - **Developing engine performance maps from RSM's**

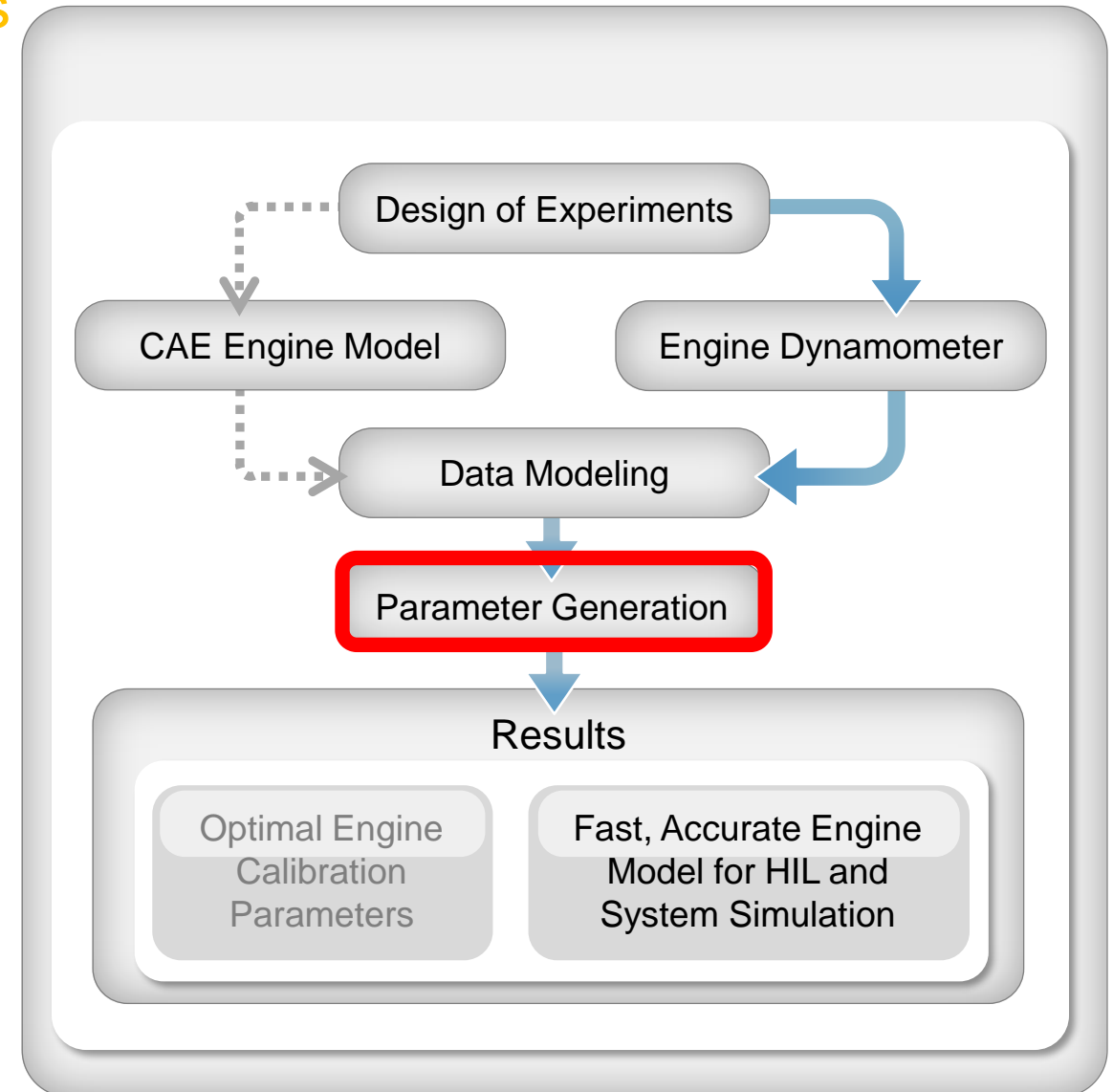

Calibration Generation Tool

- Fill tables
- Export cal tables

The screenshot shows the CAGE Browser interface with the following components:

- Models Table:**

Name	Type	Inputs	Lower Output Limit	Upper Output Limit	Description
BSFC	MBC model	ECP, EngSpd, ICP, LOAD	-Inf	Inf	Created by hhu on 05-Jul-2016.
KIT1	MBC model	ECP, EngSpd, ICP, LOAD	-Inf	Inf	Created by hhu on 05-Jul-2016.
Lam	MBC model	ECP, EngSpd, ICP, LOAD	-Inf	Inf	Created by hhu on 05-Jul-2016.
RF1	MBC model	ECP, EngSpd, ICP, LOAD	-Inf	Inf	Created by hhu on 05-Jul-2016.
SpkAdv	MBC model	ECP, EngSpd, ICP, LOAD	-Inf	Inf	Created by hhu on 05-Jul-2016.
TAP	MBC model	ECP, EngSpd, ICP, LOAD	-Inf	Inf	Created by hhu on 05-Jul-2016.
TEXH	MBC model	ECP, EngSpd, ICP, LOAD	-Inf	Inf	Created by hhu on 05-Jul-2016.
TSPEED	MBC model	ECP, EngSpd, ICP, LOAD	-Inf	Inf	Created by hhu on 05-Jul-2016.
Torque	MBC model	ECP, EngSpd, ICP, LOAD	-Inf	Inf	Created by hhu on 05-Jul-2016.
WAP	MBC model	ECP, EngSpd, ICP, LOAD	-Inf	Inf	Created by hhu on 05-Jul-2016.
- Optimization Panel:** A central panel titled "Create an optimization for a model and use results to fill tables." It contains a sub-section "Use models to generate calibration" with five icons: "Import Models", "Optimization", "Tables and Tradeoff", "Feature", "Data set", and "Export Tables". The "Optimization" and "Export Tables" icons are highlighted with a red border.
- Connections Panel:** Shows a diagram with two red ovals labeled "ICP" and "LOAD" connected by arrows.
- BSFC Plot:** A 3D surface plot showing the relationship between ECP (X-axis, 0-50), EngSpd (Y-axis, 0-5000), and BSFC (Z-axis, 240-320).

Calibration Generation Tool

- Generating look up tables

CAGE Browser - BaseCalibrationCage_ModelImport.cag

File Edit View Model Tools Window Help

Processes

Name	Type	Inputs	Lower Output Limit	Upper Output Limit	Description
BSFC	MBC model	ECP, EngSpd, ICP, LOAD	-Inf	Inf	Created by hhu on 05-Jul-2016.
KIT1	MBC model	ECP, EngSpd, ICP, LOAD	-Inf	Inf	Created by hhu on 05-Jul-2016.
Lam	MBC model	ECP, EngSpd, ICP, LOAD	-Inf	Inf	Created by hhu on 05-Jul-2016.
RF1	MBC model	ECP, EngSpd, ICP, LOAD	-Inf	Inf	Created by hhu on 05-Jul-2016.
SpkAdv	MBC model	ECP, EngSpd, ICP, LOAD	-Inf	Inf	Created by hhu on 05-Jul-2016.
TAP	MBC model	ECP, EngSpd, ICP, LOAD	-Inf	Inf	Created by hhu on 05-Jul-2016.
TEXH	MBC model	ECP, EngSpd, ICP, LOAD	-Inf	Inf	Created by hhu on 05-Jul-2016.
TSPPEED	MBC model	ECP, EngSpd, ICP, LOAD	-Inf	Inf	Created by hhu on 05-Jul-2016.
Torque	MBC model	ECP, EngSpd, ICP, LOAD	-Inf	Inf	Created by hhu on 05-Jul-2016.
WAP	MBC model	ECP, EngSpd, ICP, LOAD	-Inf	Inf	Created by hhu on 05-Jul-2016.

Create an optimization for a model and use results to fill tables.

Use models to generate calibration

Import Models Optimization **Tables and Tradeoff** Feature Data set Export Tables

Items that use BSFC

Item	Type
------	------

Open

Connections

ICP

LOAD

BSFC

X-axis: ECP Y-axis: EngSpd

Ready

Calibration Generation Tool

- Fill tables

- Inspect surfaces
- Adjust table values in extrapolation areas
- Export to MATLAB, Excel or Cal tool

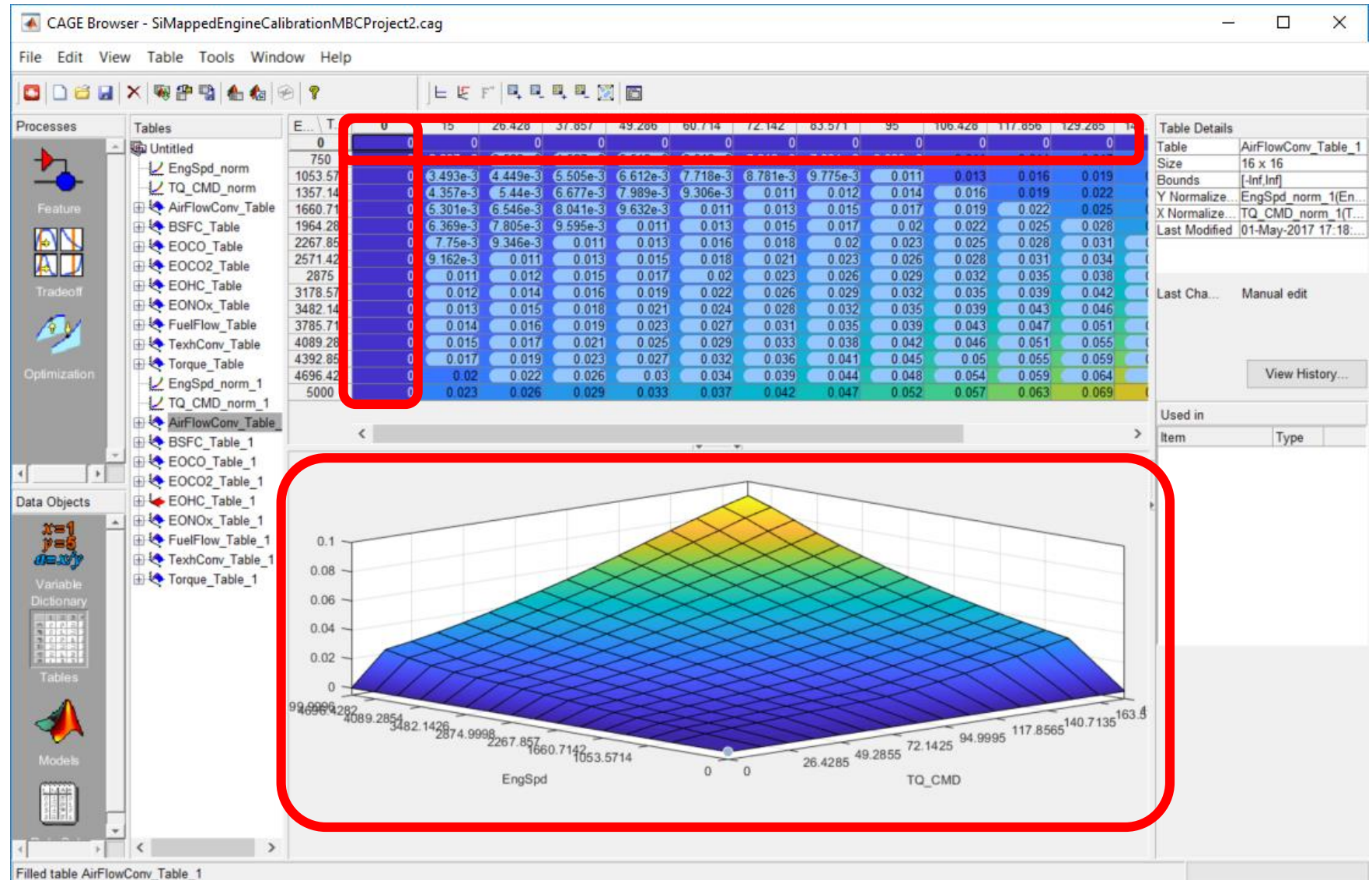

Parameterizing a Mapped Engine Model

- Export and validate result

- Mapped engine model workflow:
 - Importing existing data
 - Fitting response surface models
 - Developing engine performance maps
 - **Export and validate the result**

Use models to generate calibration

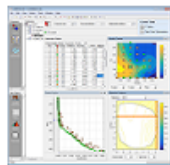

Optimization

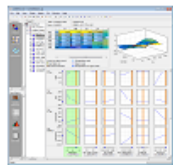

Tables and Tradeoff

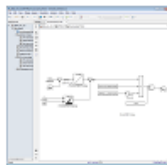

Feature

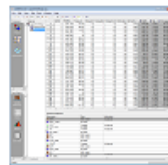

Data set

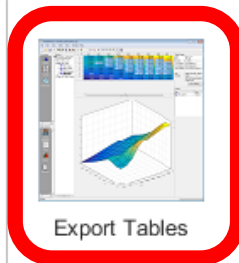

Export Tables

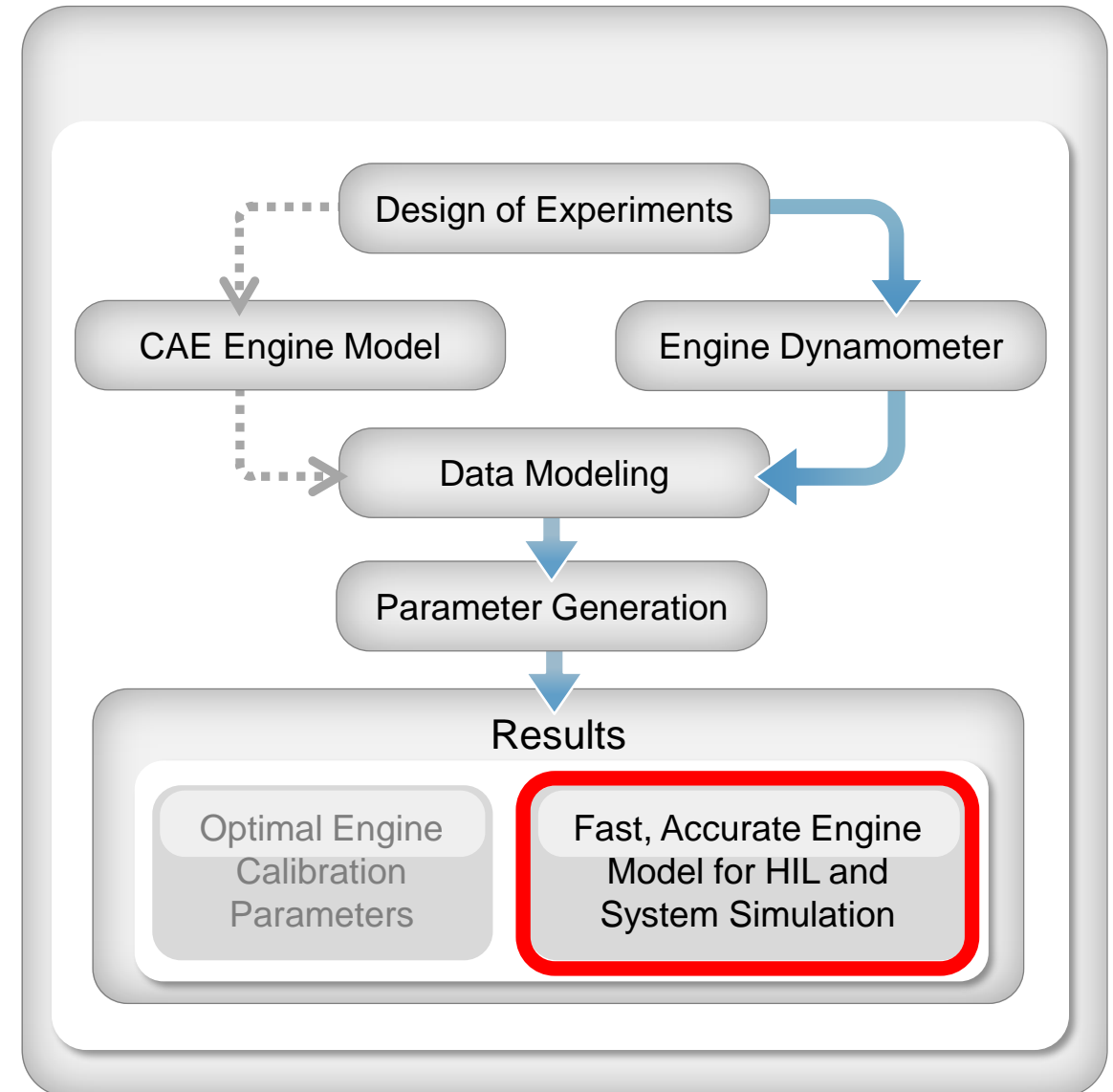

Export Tables to MATLAB

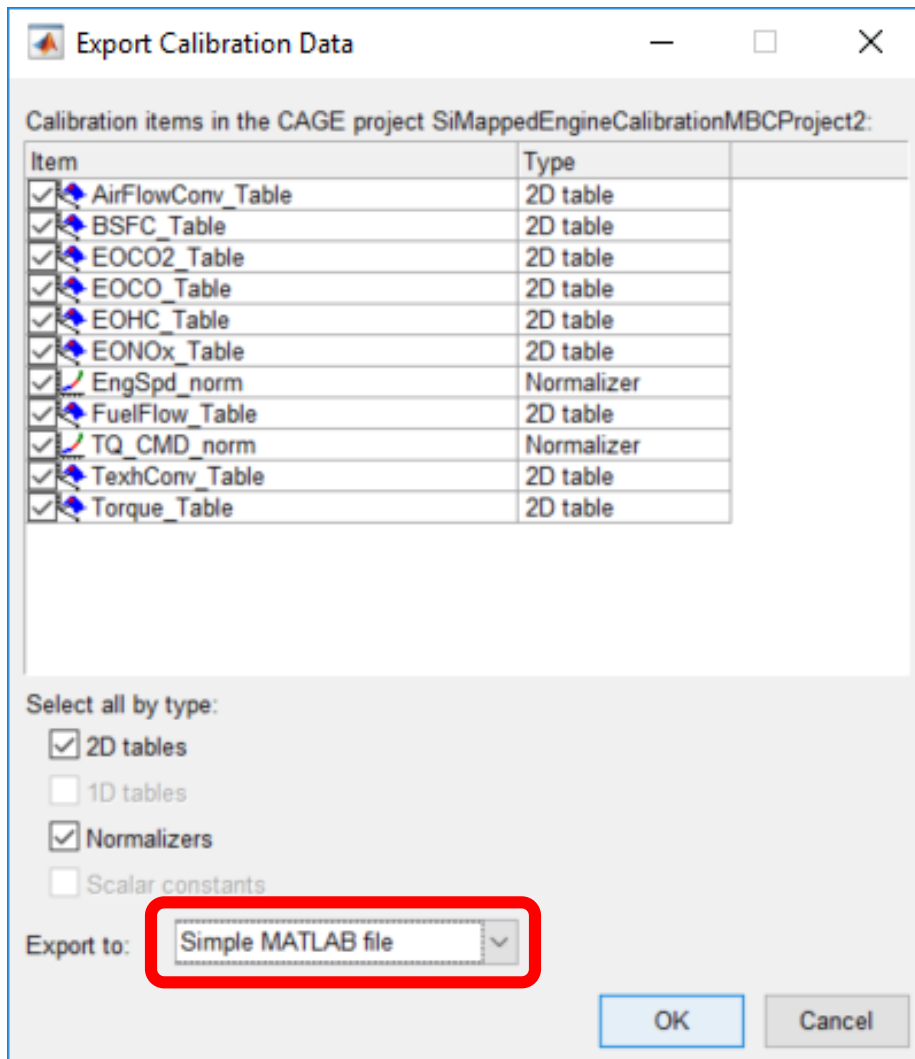

```

Editor - C:\Demo_HEVMM\Demo\EngineData\SiMappedEngineCalibrations2.m
t2_openAndConfigurePlantModel.m x t1_openReferenceApplication.m x runGFXDoE.m x runGFXPoint.m x Dynam
1 | %SIMAPPEDENGINECALIBRATIONS2 Calibration MATLAB file.
2
3 | % Generated by MATLAB 9.2.0.538062 (R2017a) on 01-May-2017 19:19:54
4
5 - EngSpd_norm_1.X = [ 0, 750, 1053.5714, 1357.1428, 1660.7142, 1964.2857]
6 - EngSpd_norm_1.Y = [ 0, 1, 2, 3, 4, 5, 6, 7, 8, 9, 10, 11, 12, 13, 14]
7
8 - TQ_CMD_norm_1.X = [ 0, 15, 26.4285, 37.857, 49.2855, 60.714, 72.1425]
9 - TQ_CMD_norm_1.Y = [ 0, 1, 2, 3, 4, 5, 6, 7, 8, 9, 10, 11, 12, 13, 14]
10
11 - AirFlowConv_Table_1.X = [ 0, 15, 26.4285, 37.857, 49.2855, 60.714, 72.1425]
12 - AirFlowConv_Table_1.Y = [ 0, 750, 1053.5714, 1357.1428, 1660.7142, 1964.2857]
13 - AirFlowConv_Table_1.Z(1,:) = [ 0, 0, 0, 0, 0, 0, 0, 0, 0, 0, 0, 0, 0, 0, 0]
14 - AirFlowConv_Table_1.Z(2,:) = [ 0, 0.0022967, 0.0035882, 0.0045269, 0.0054676, 0.0064083, 0.0073490, 0.0082897, 0.0092304, 0.0101711, 0.0111118, 0.0120525, 0.0129932, 0.0139339, 0.0148746]
15 - AirFlowConv_Table_1.Z(3,:) = [ 0, 0.0034933, 0.0044495, 0.0055057, 0.0065619, 0.0076181, 0.0086743, 0.0097305, 0.0107867, 0.0118429, 0.0128991, 0.0139553, 0.0150115, 0.0160677, 0.0171239]
16 - AirFlowConv_Table_1.Z(4,:) = [ 0, 0.0043571, 0.0054403, 0.0066774, 0.0079145, 0.0091516, 0.0103887, 0.0116258, 0.0128629, 0.0140999, 0.0153370, 0.0165741, 0.0178112, 0.0190483, 0.0202854]
17 - AirFlowConv_Table_1.Z(5,:) = [ 0, 0.0053006, 0.0065457, 0.0080411, 0.0095365, 0.0110319, 0.0125273, 0.0140227, 0.0155181, 0.0170135, 0.0185089, 0.0200043, 0.0214997, 0.0229951, 0.0244905]
18 - AirFlowConv_Table_1.Z(6,:) = [ 0, 0.0063694, 0.0078051, 0.0095947, 0.0113843, 0.0131739, 0.0149635, 0.0167531, 0.0185427, 0.0203323, 0.0221219, 0.0239115, 0.0257011, 0.0274907, 0.0292803]
19 - AirFlowConv_Table_1.Z(7,:) = [ 0, 0.0077497, 0.009346, 0.011301, 0.013356, 0.015411, 0.017466, 0.019521, 0.021576, 0.023631, 0.025686, 0.027741, 0.029796, 0.031851, 0.033906]
20 - AirFlowConv_Table_1.Z(8,:) = [ 0, 0.0091619, 0.010918, 0.013036, 0.015154, 0.017272, 0.019390, 0.021508, 0.023626, 0.025744, 0.027862, 0.029980, 0.032098, 0.034216, 0.036334]
21 - AirFlowConv_Table_1.Z(9,:) = [ 0, 0.010518, 0.012419, 0.014712, 0.017005, 0.019298, 0.021591, 0.023884, 0.026177, 0.028470, 0.030763, 0.033056, 0.035349, 0.037642, 0.039935]

```

Validate the Result

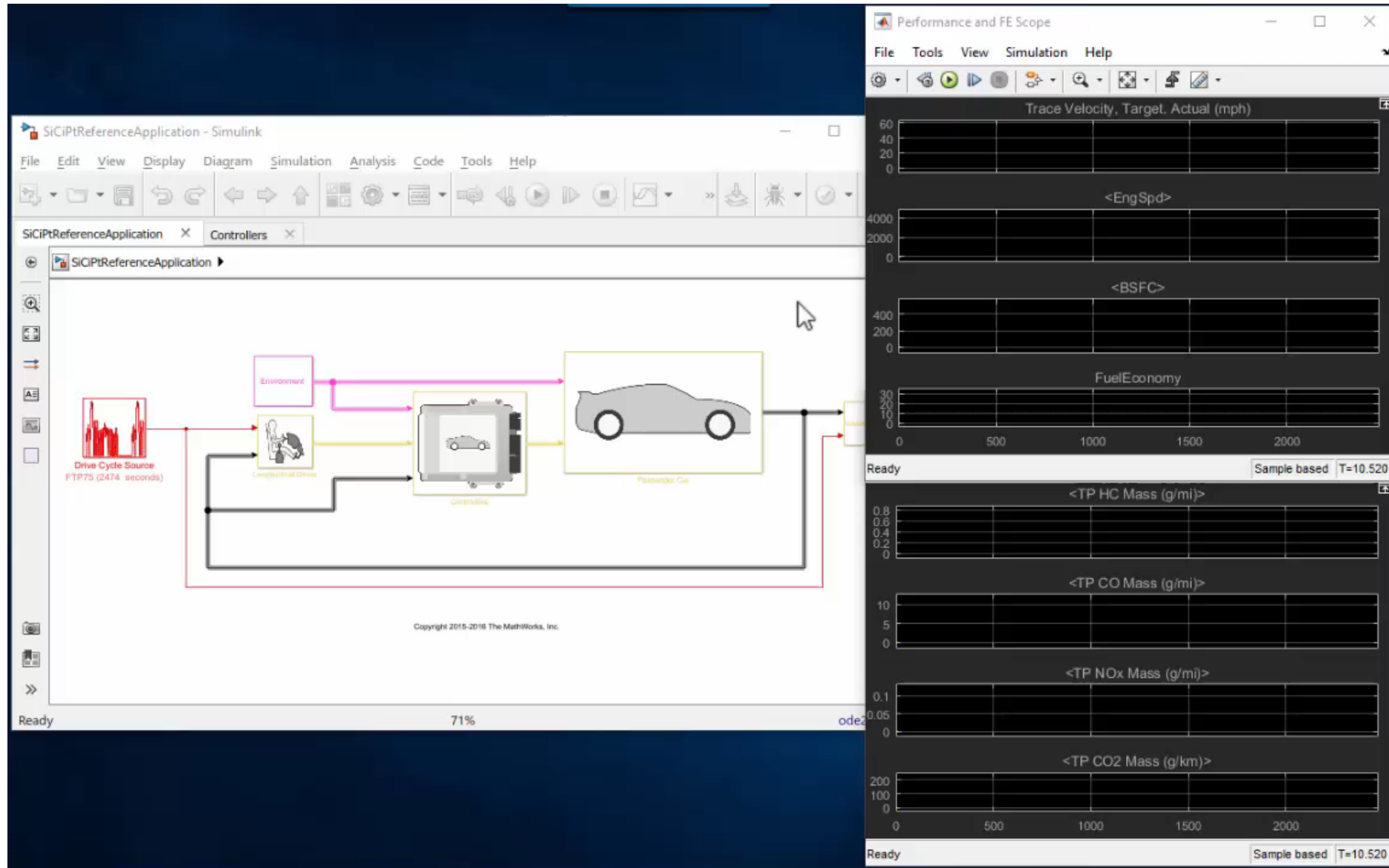

Validate the Result

- Accuracy for 1200 sec of FTP75 sim:
 - % diff in FE was 0.31%
- Run time for 1200 sec of FTP75 sim:
 - PTBS Mapped engine model 28.4 sec
 - GT Power FRM engine model 1449 sec
 - Mapped engine model sim ~51x faster

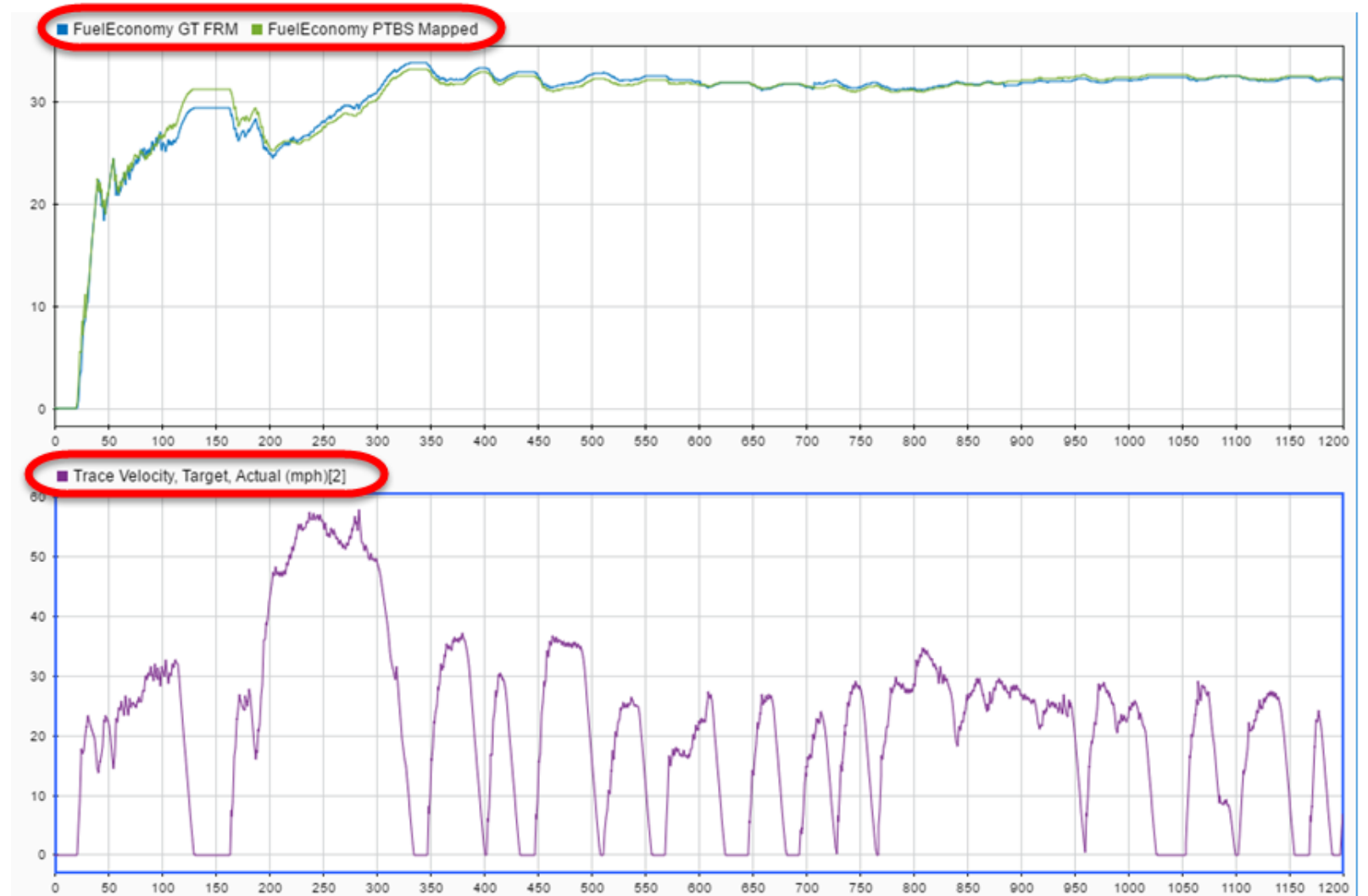

Parameterizing a Mapped Engine Model

- Summary

- Mapped engine model workflow:
 - Importing existing data
 - Fitting response surface models (RSM, statistical) to the data
 - Developing engine performance maps from RSM's
 - Validate the result

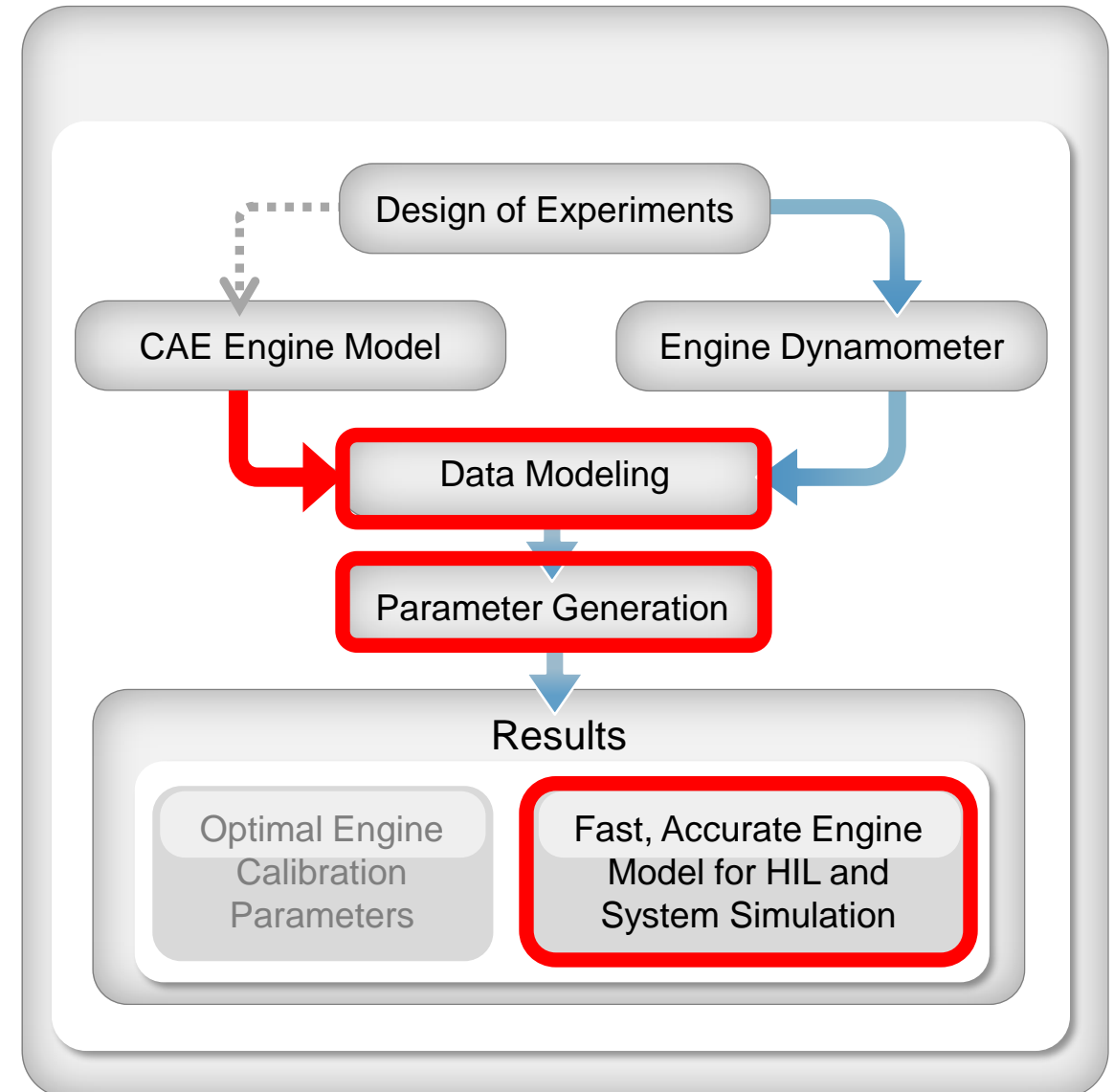

What we'll Cover Today

- Parameterizing a Powertrain Blockset engine model
 - Workflow
 - Example: parameterizing a mapped engine model

- **Calibrating a Powertrain Blockset engine controller**
 - **Workflow**
 - **Example: calibrating an engine controller**

What are we Parameterizing and Calibrating?

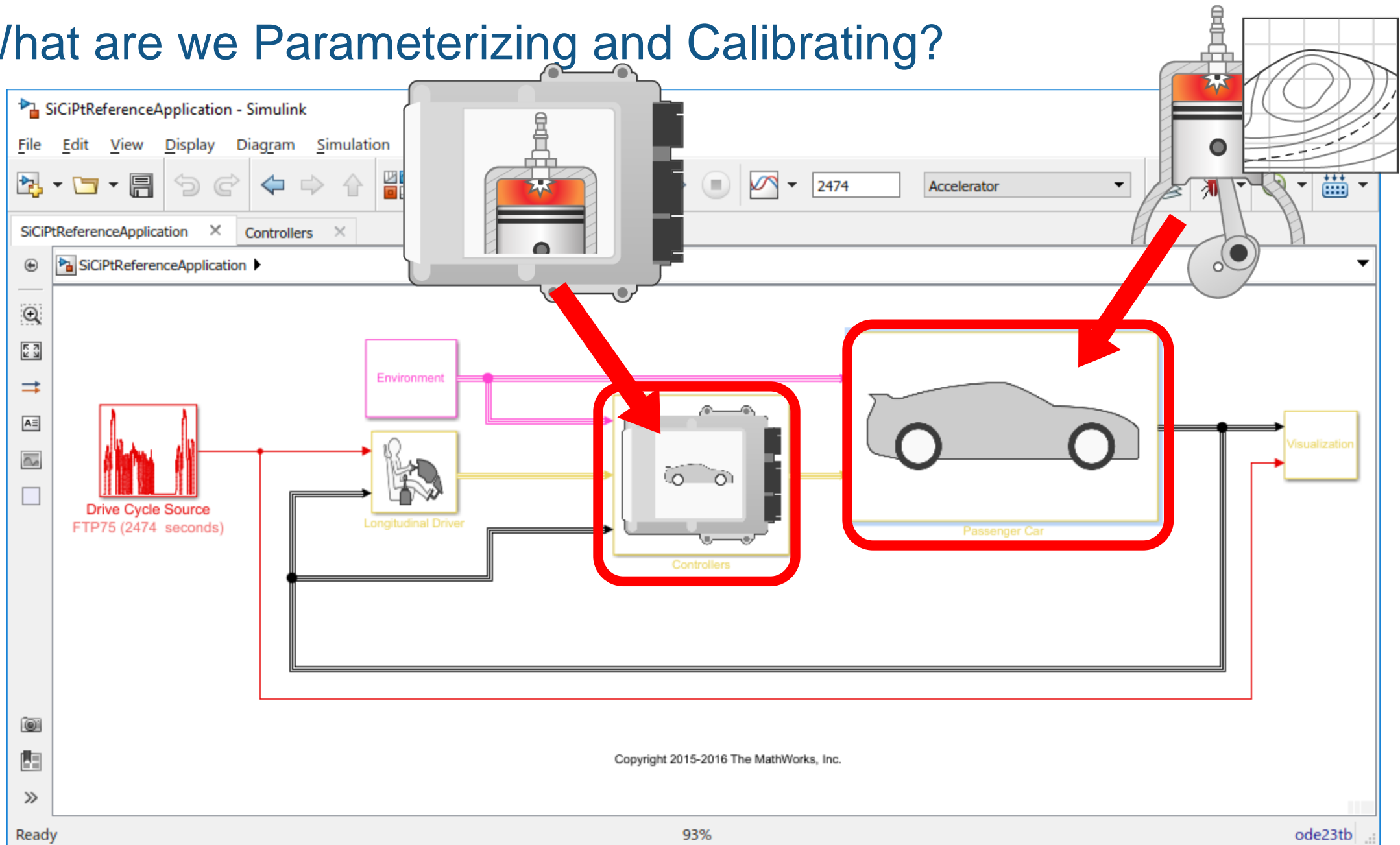

Copyright 2015-2016 The MathWorks, Inc.

What are we Calibrating?

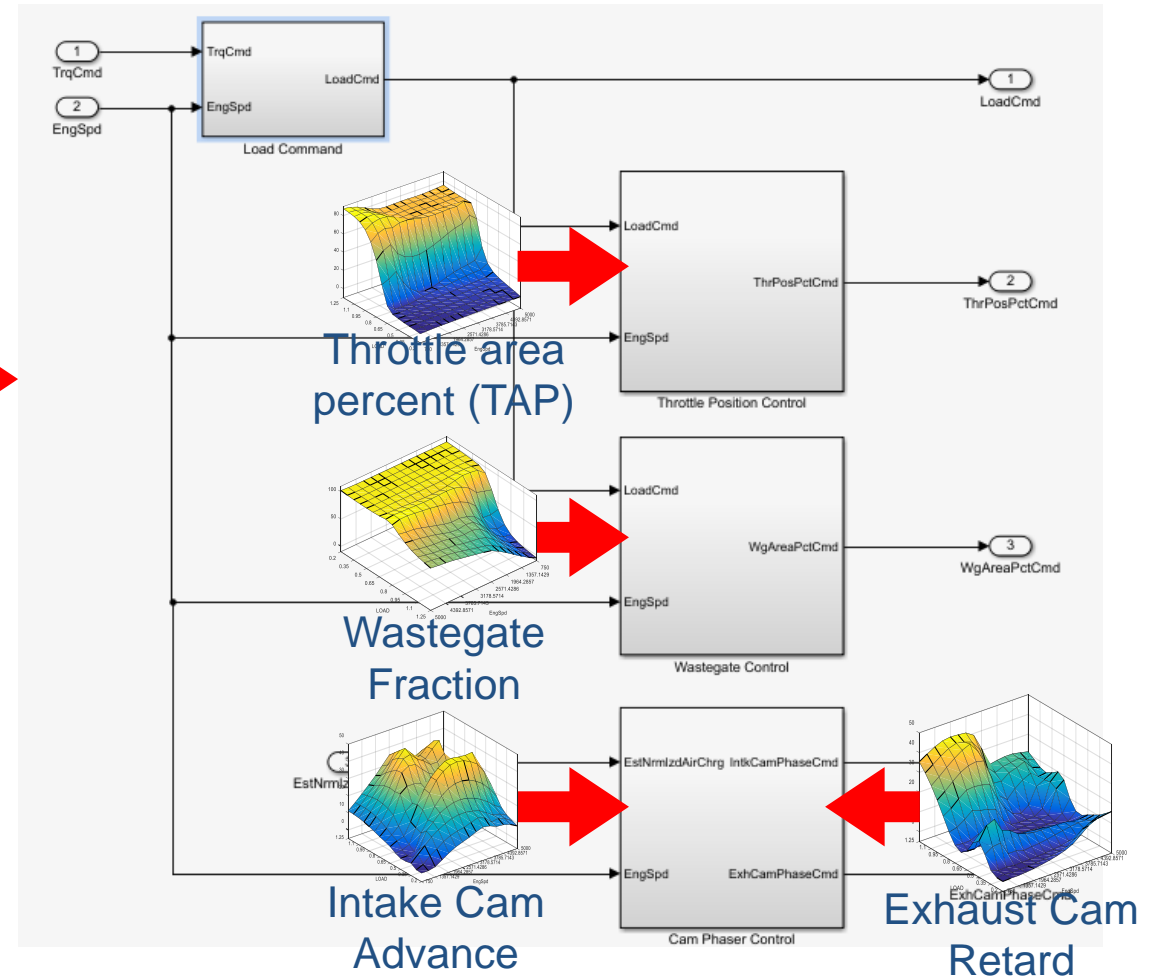
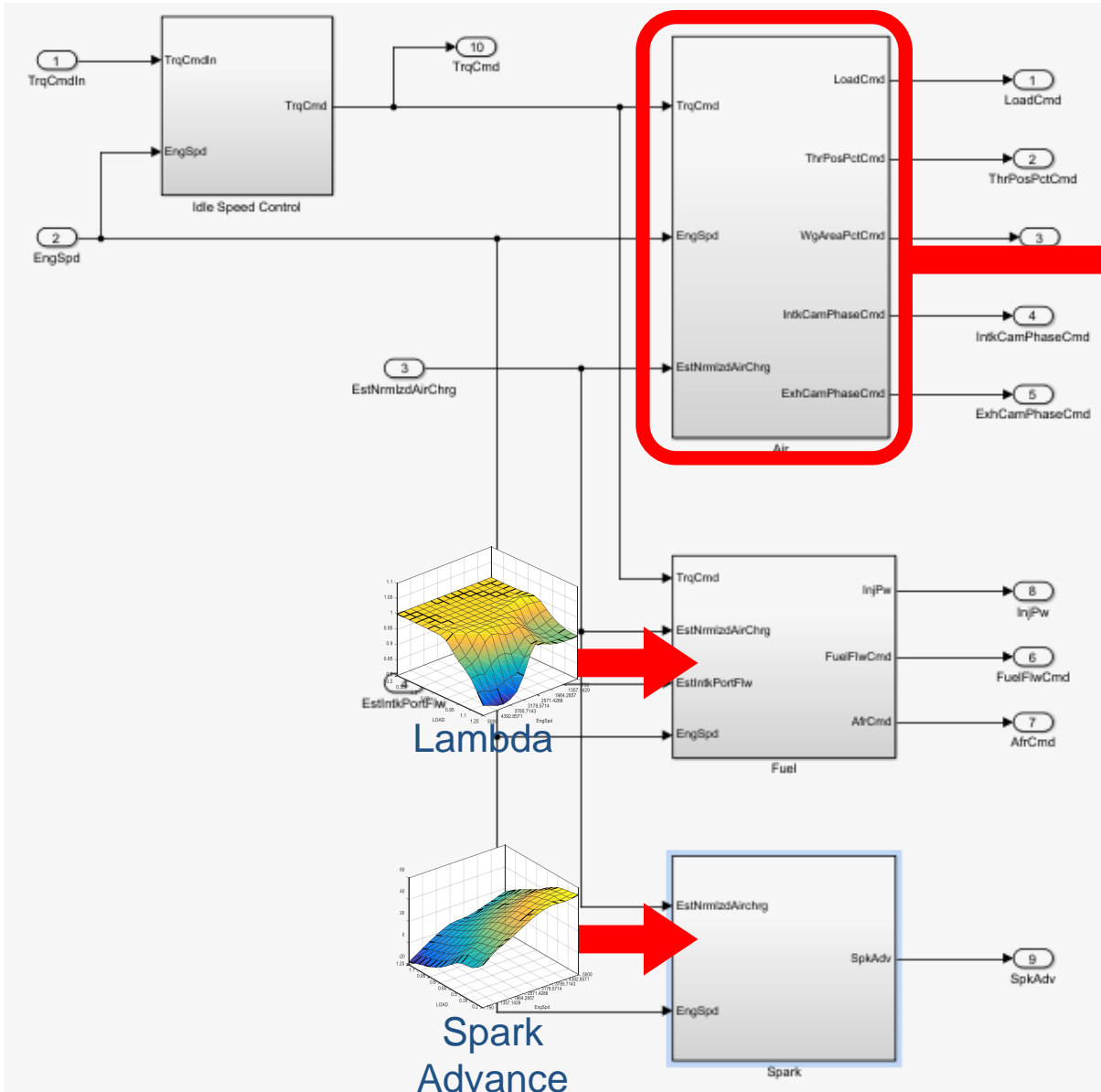

Calibrating Optimal Base Engine Control Tables

- Workflow

- Model-Based Calibration Toolbox provides tools for the process:
 - Creating the Design of Experiments
 - Gather the data
 - Fitting response surface models (RSM, statistical) to the data
 - Developing optimal base calibration tables
 - Export calibration to controller

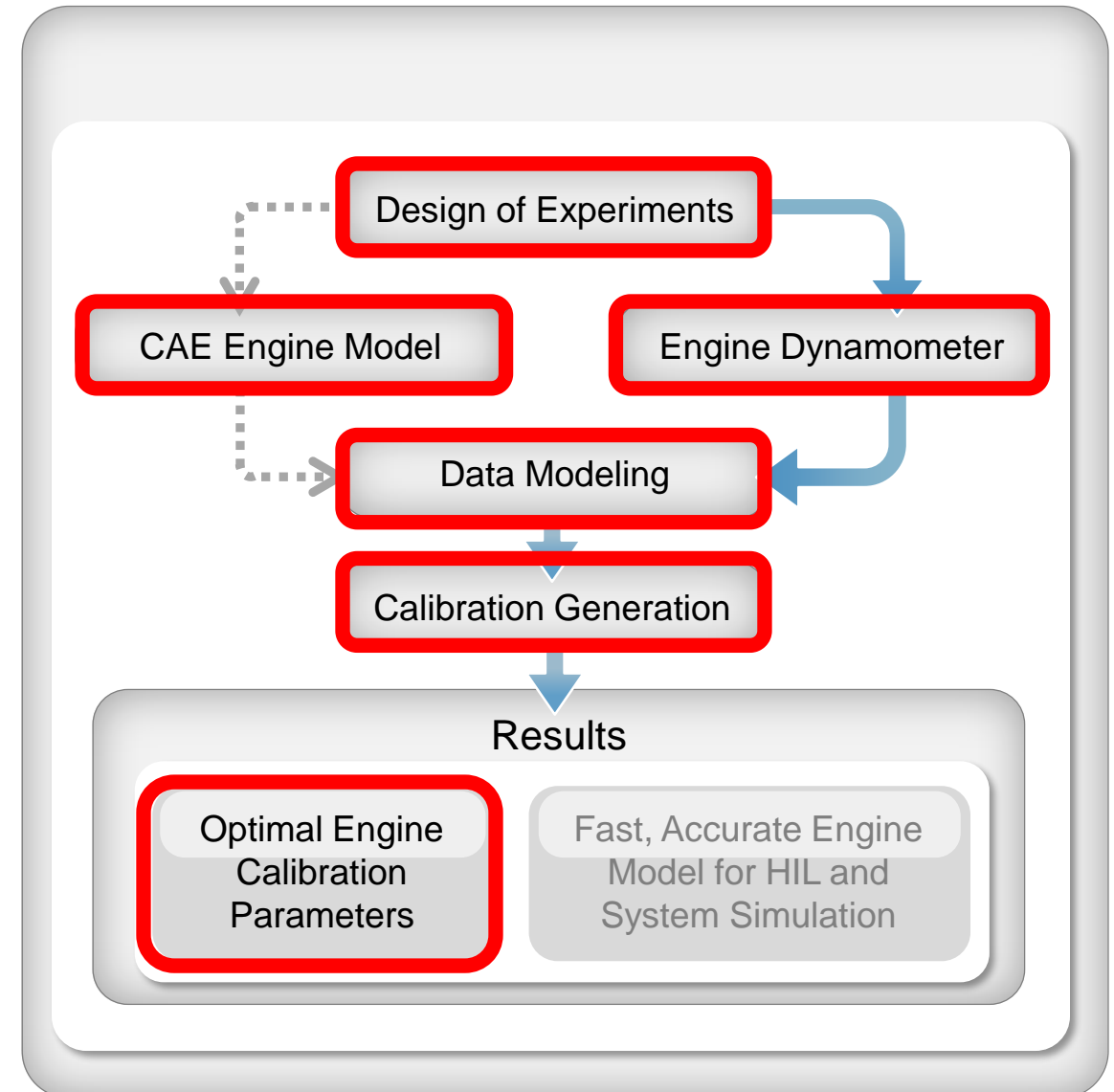

Calibrating Optimal Base Engine Control Tables

- Creating the DoE

- Optimal base engine control calibration workflow:

- **Creating the Design of Experiments**

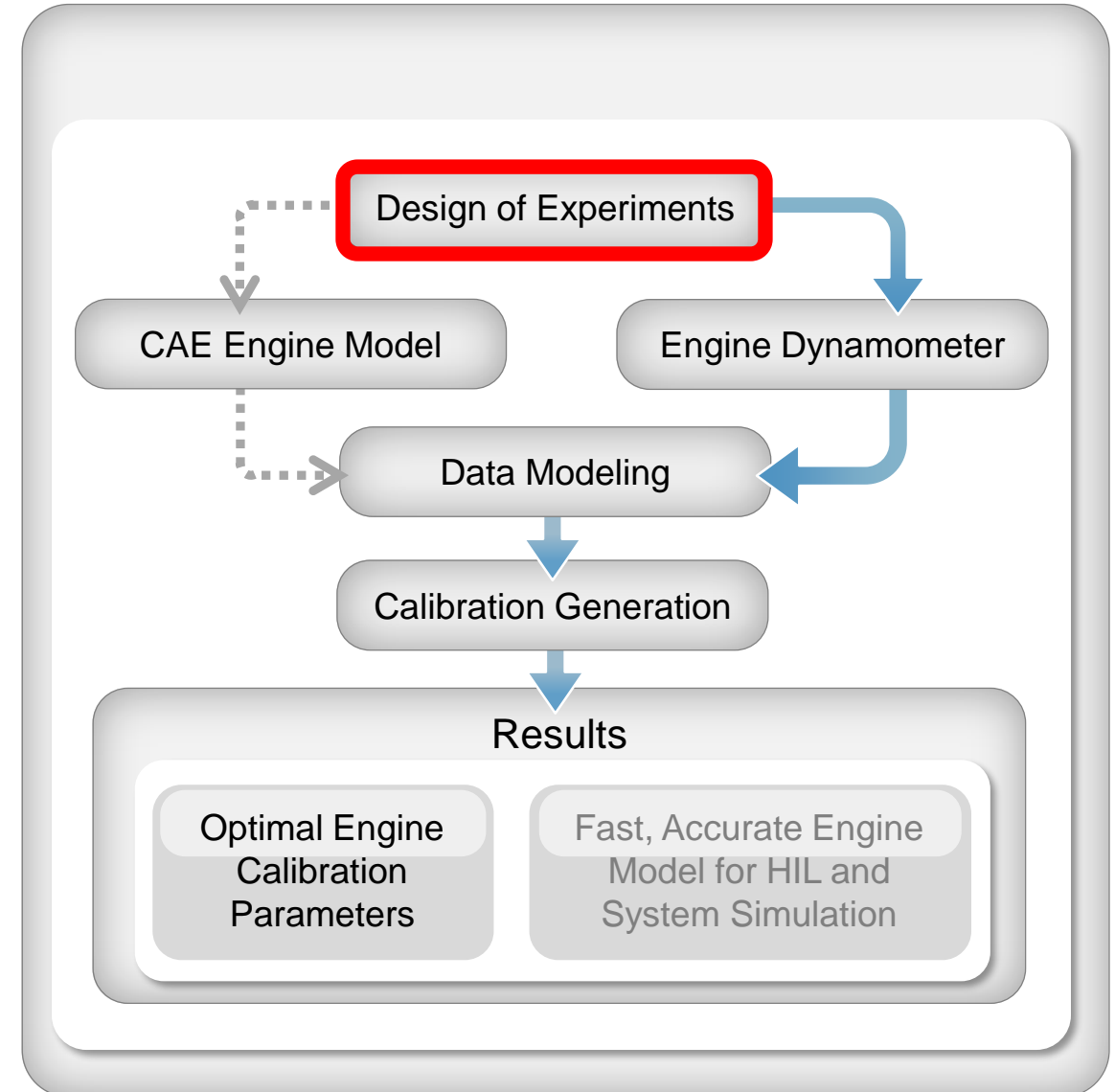

Calibrating Optimal Base Engine Control Tables

- Creating the DoE

I/O of Turbocharged Direct-Injection 1.5L DOHC Engine Model with Dual-Independent Continuously Variable Cam Phasing

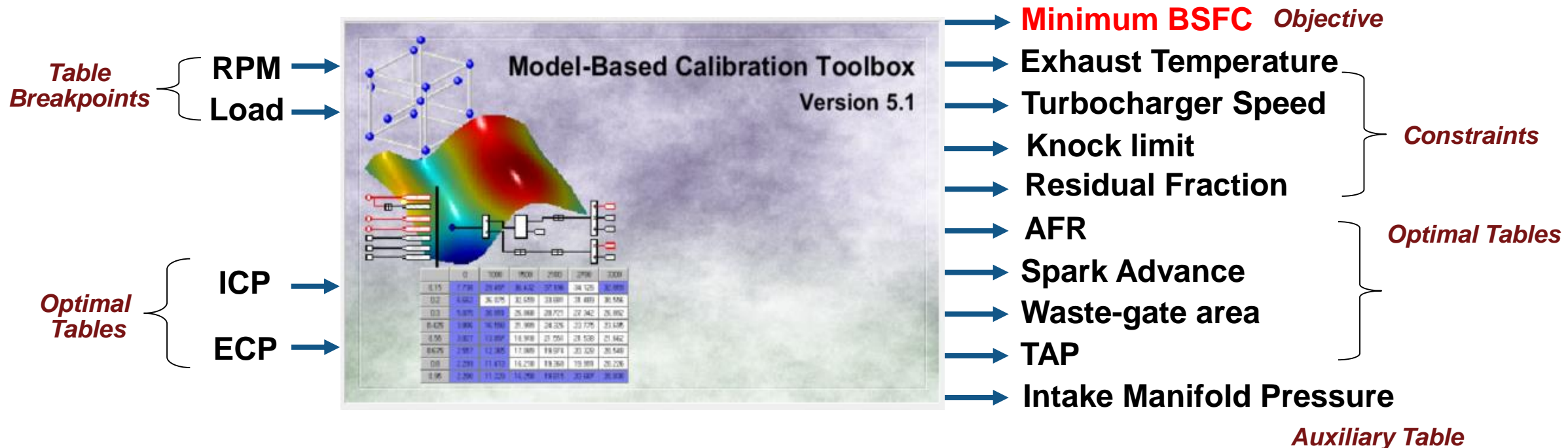

Calibrating Optimal Base Engine Control Tables

- Creating the DoE

Space-Filling Design Browser

Design type: Sobol Sequence

Number of points: 200 Constraints present

Options

Sequence size: 247

No skip
 Skip initial 2^k points
 Custom skip: 0

Apply Matousek Affine Owen scramble

Input Factor	Min	Max
EngSpd	650	5000
TQ_CMD	10	175
ICP	0	50
ECP	0	50

Generate Automatically update preview

1D 2D 3D 4D

Preview

Design Editor - [BaseCalibrationDoE]

File Edit View Design Tools Window Help

Design Tree

- Designs
 - BaseCalibrationDoE
 - BaseCalibrationDoE_Idle
 - BaseCalibrationDoE_Merged

Pairwise Projections

Properties - BaseCalibrationDoE_Merged

Design Style	Custom
Number of Points	225
Number of Constraints	2
Last Changed	05-Jul-2016, 10:58:32
Model	GPM-ARDSquaredEx...

BaseCa... Scott Furry

File Home Insert Page Formulas Data Review View Developer Tools

D3

	A	B	C	D	E
1	EngSpd	TqCmd	ICP	ECP	
2	RPM	Nm	degCrkAdv	degCrkRet	
3	700	32	0	0	
4	700	48	0	0	
5	700	64	39	47	
6	750	28	0	0	
7	750	34	0	0	
8	750	42	37	12	
9	750	76	22	40	
10	800	16	0	0	
11	800	2	0	0	
12	800	32	46	18	
13	850	40	0	0	
14	850	44	0	0	
15	850	54	30	29	
16	900	18	0	0	

Two red arrows point from the 3D preview plot in the Design Editor to the corresponding ICP vs EngSpd and TQ_CMD vs EngSpd pairwise projection plots. A third red arrow points from the Design Editor's 'Generate' button to the Excel spreadsheet, indicating the export of the design data.

Calibrating Optimal Base Engine Control Tables

- Gather the data

- Optimal base engine control calibration workflow:
 - Creating the Design of Experiments
 - **Gather the data**

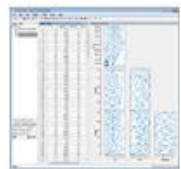
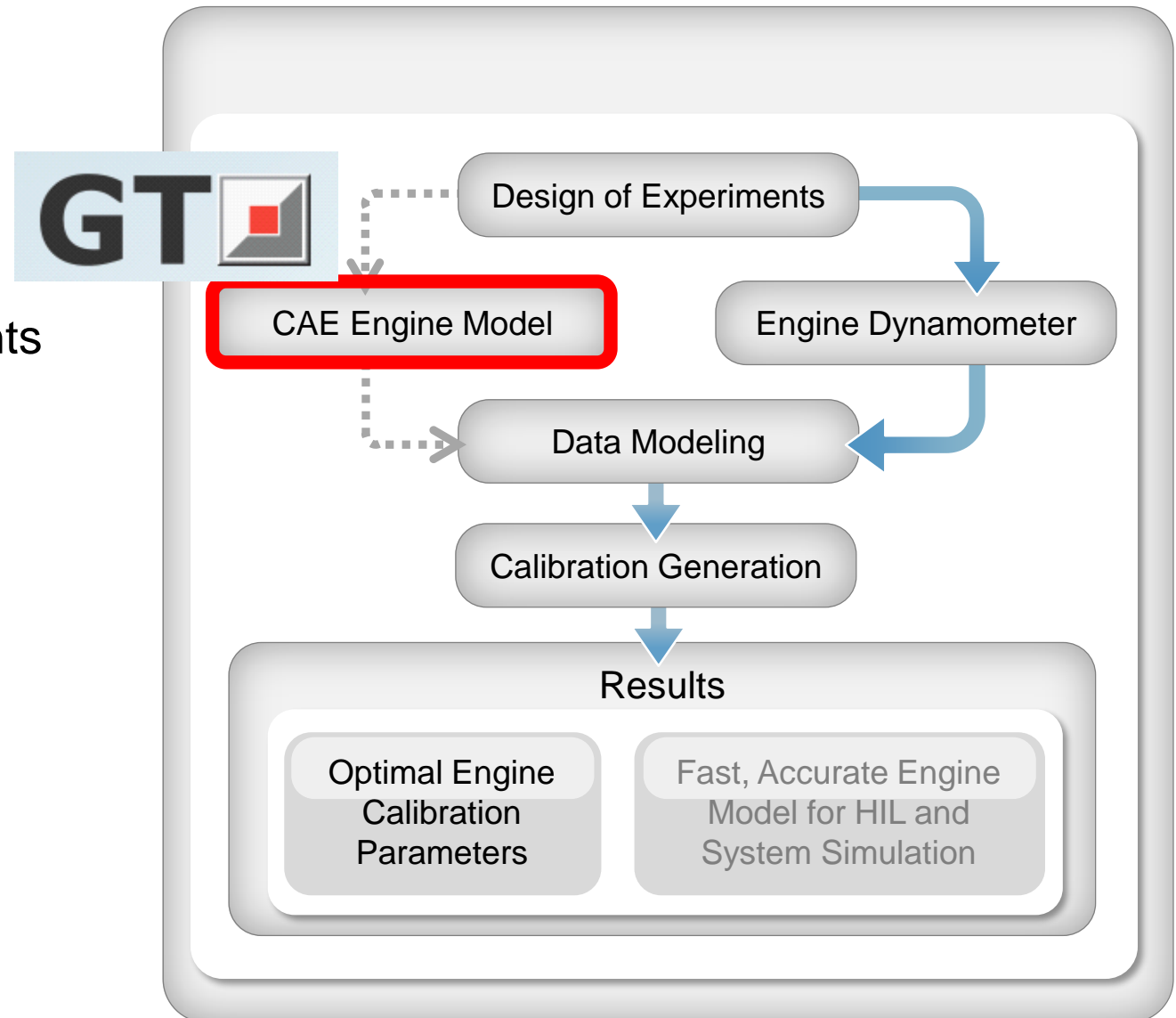

Design Experiment

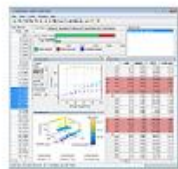

Import Data

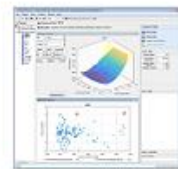

Fit Models

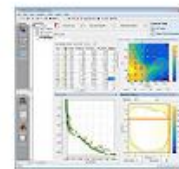

Generate Calibration

Calibrating an Optimal Base Cal Table

- Get the data "from CAE engine models"

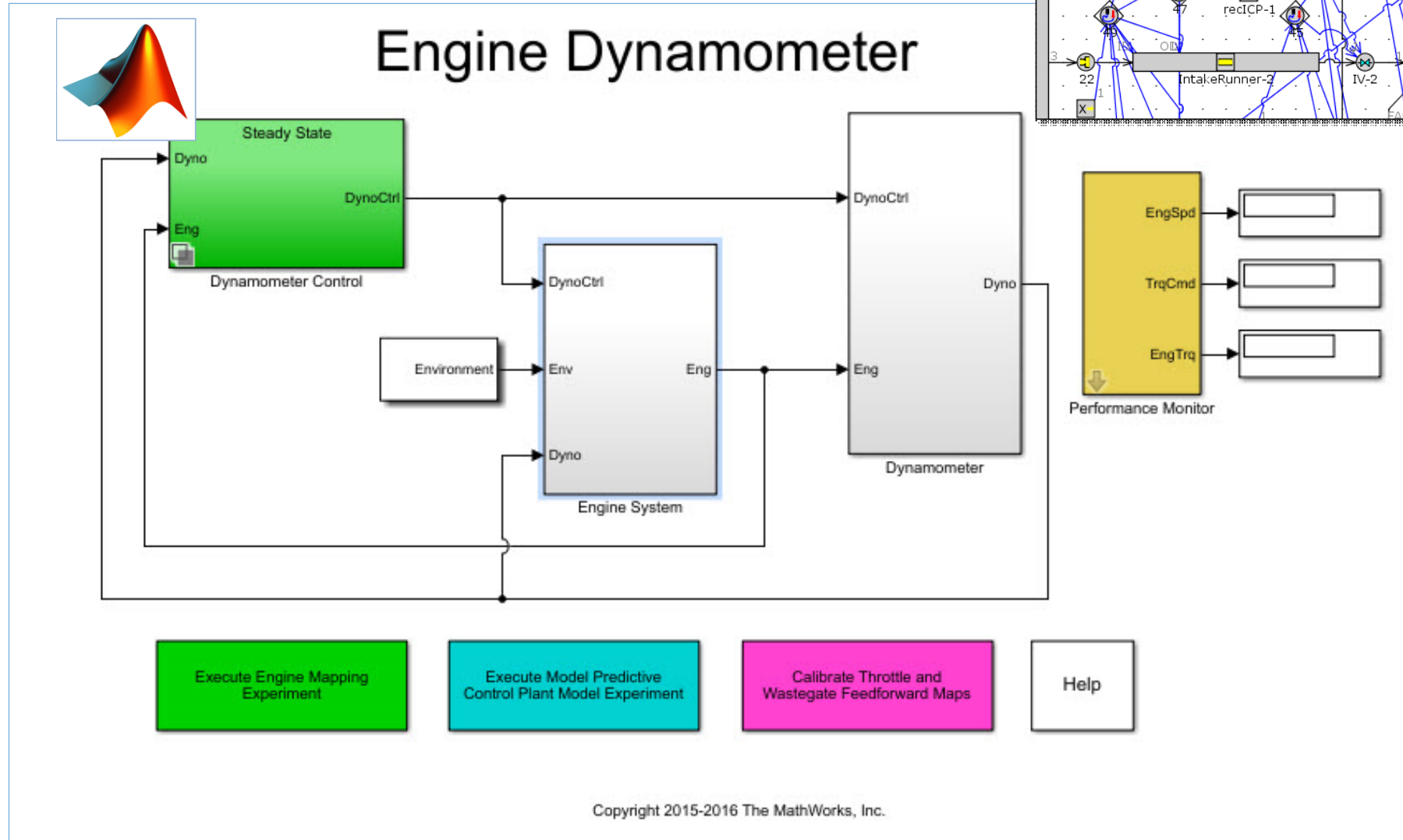
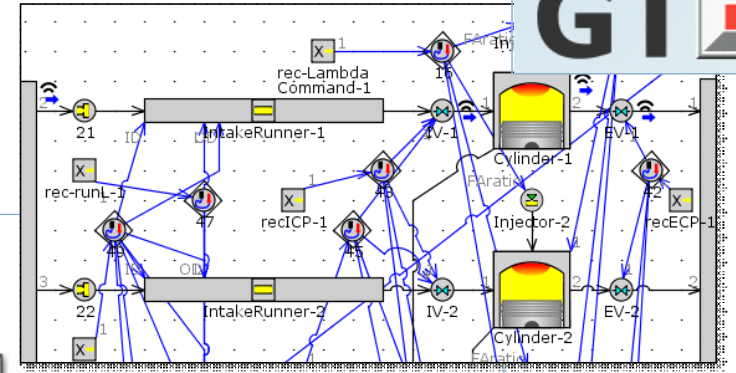

Calibrating Optimal Base Engine Control Tables

- Get the data "from calibration sweeps"

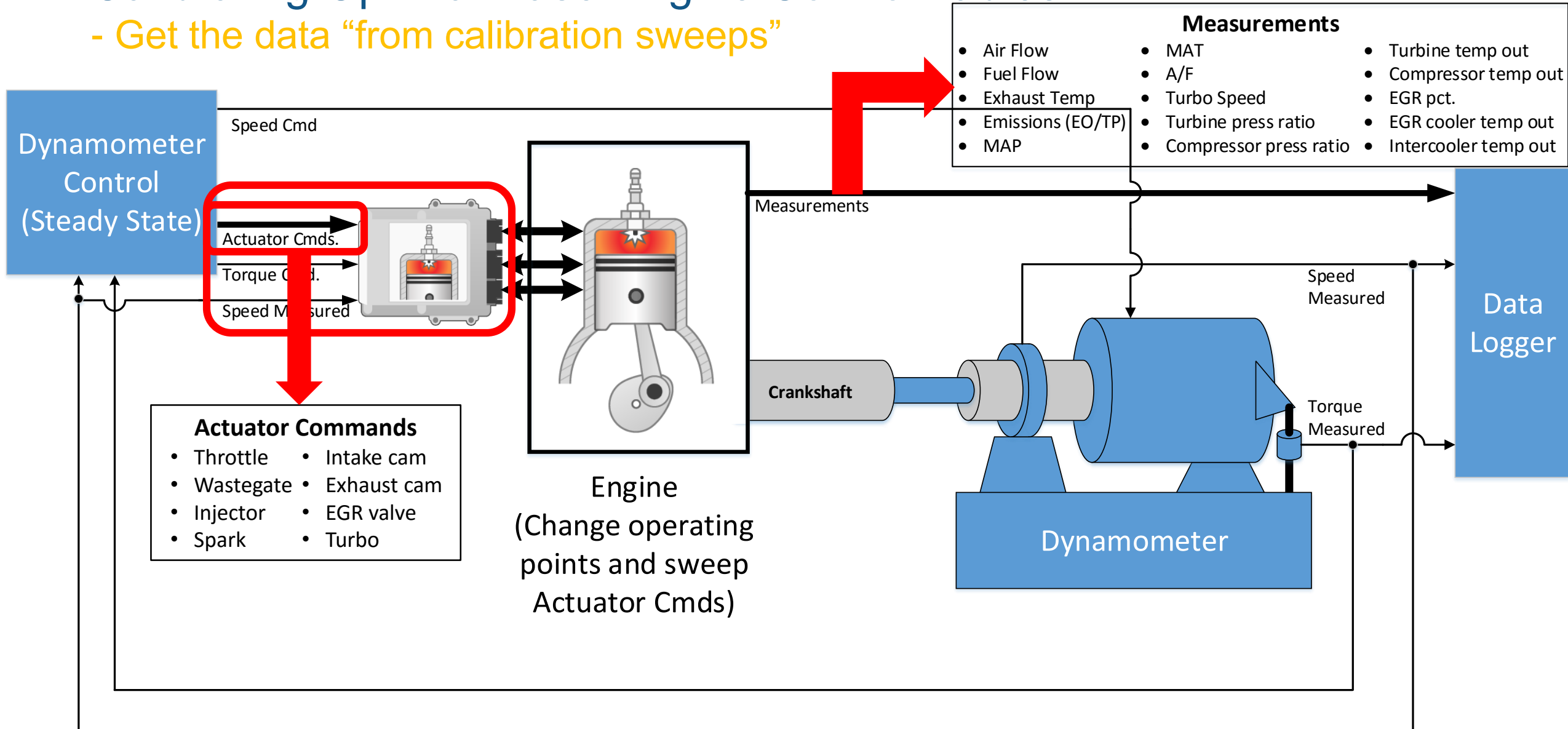

Calibrating Optimal Base Engine Control Tables

- Fitting response surface models

- Optimal base engine control calibration workflow:
 - Creating the Design of Experiments
 - Gather the data
 - **Fitting response surface models (RSM, statistical) to the data**

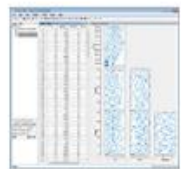
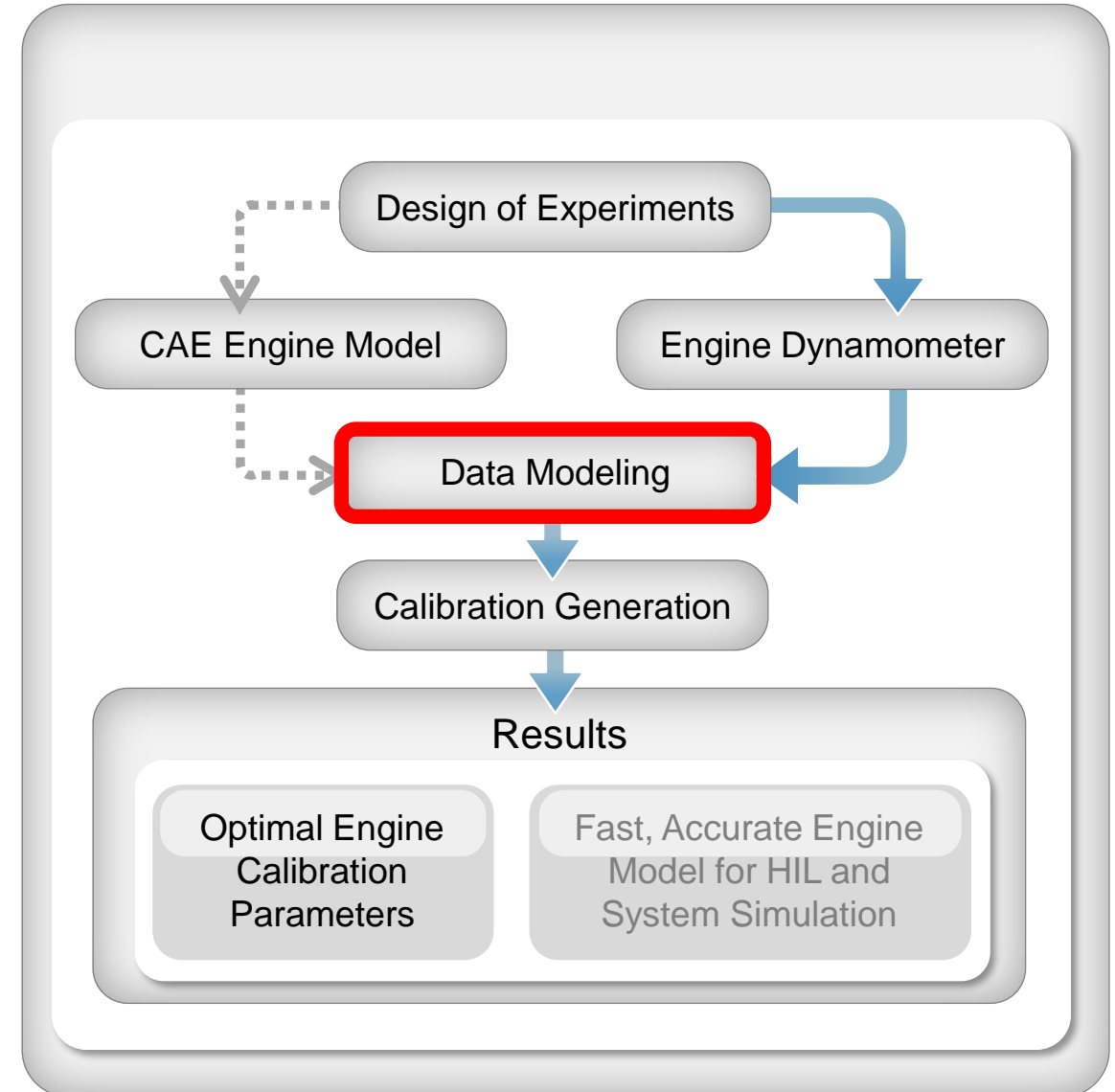

Design Experiment

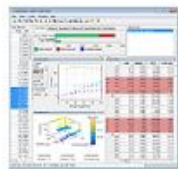

Import Data



Fit Models

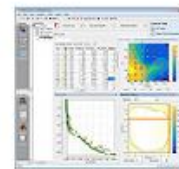

Generate Calibration

Calibrating Optimal Base Engine Control Tables

- Generate response surface models from data

- Default models automatically fitted to all responses
- Inspect quality of fit
- Try out alternatives

The screenshot displays the MathWorks Model Browser interface for a Gaussian Process Model (ARDSquaredExponential, Constant) applied to the response variable BSFC. The model is fitted to data from the 'BaseCalibrationDoE' dataset.

Model Parameters:

Name	Value	Tolerance
ECP	0.50	Linked to X...
Eng...	700:86:500	Linked to Y...
ICP	25	1
LOAD	0.7904692	0.0237733

Diagnostic Statistics Summary Table:

Observations	198
Parameters	14.327
Box-Cox	1
PRESS RMSE	63.479
RMSE	58.922
Validation RMSE	45.687

The interface also shows a 3D surface plot of BSFC [g/kWh] versus ECP [degCrkRet] and EngSpd [RPM], and a residual plot of Residuals [g/kWh] versus Predicted BSFC [g/kWh]. A 'Create Alternatives...' button is highlighted in the Common Tasks panel.

Calibrating Optimal Base Engine Control Tables

- Develop optimal base calibration tables

- Optimal base engine control calibration workflow:
 - Creating the Design of Experiments
 - Gather the data
 - Fitting response surface models
 - **Developing optimal base calibration tables from RSMs**

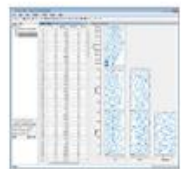
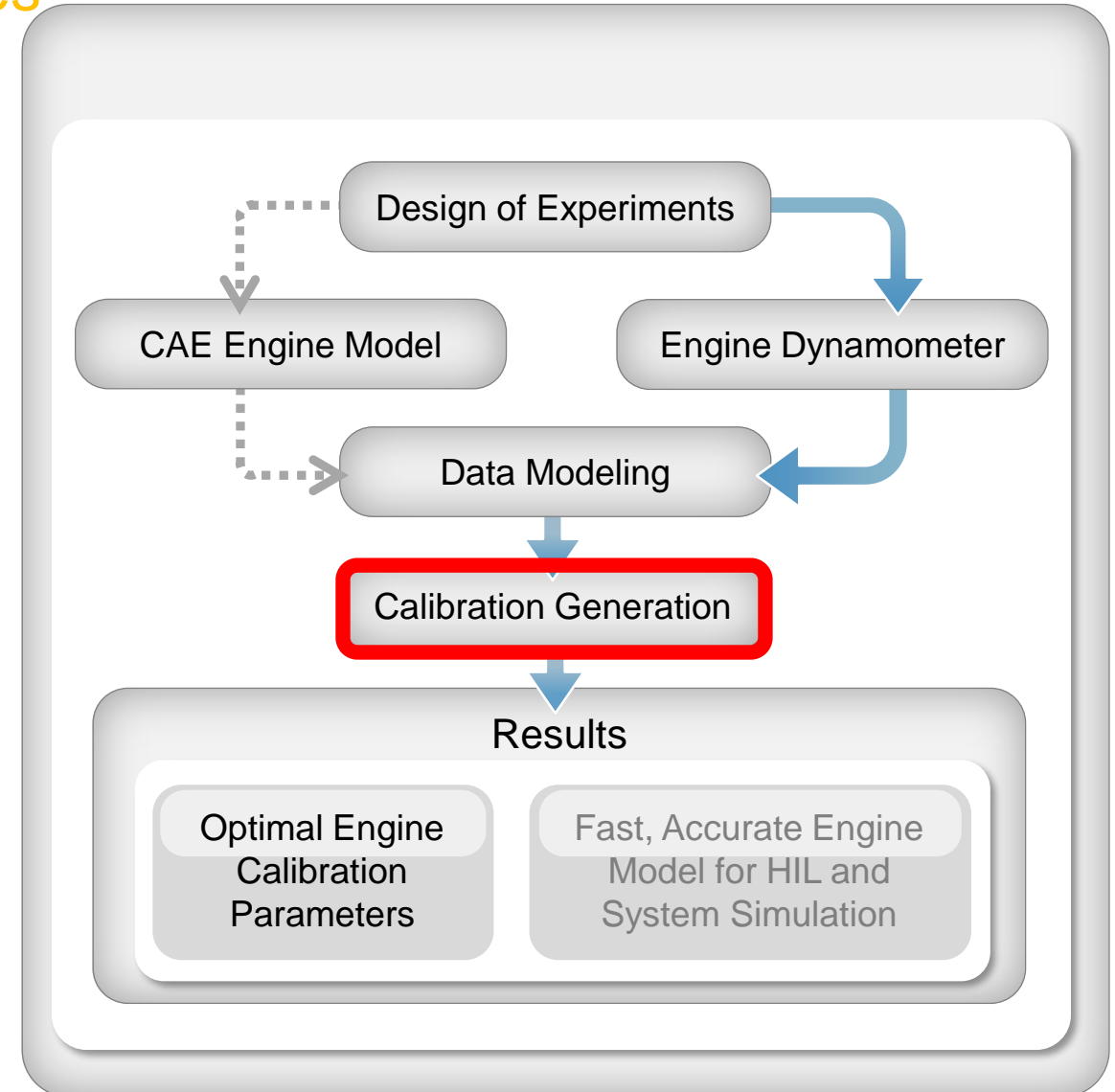

Design Experiment

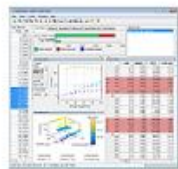

Import Data

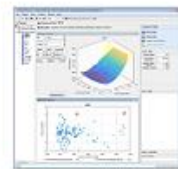

Fit Models

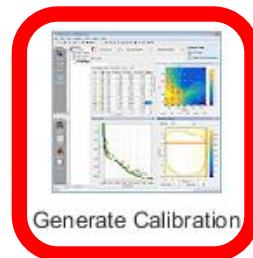

Generate Calibration

Calibrating Optimal Base Engine Control Tables

- Developing calibration tables

- Import response surface models
- Run optimizations
- Analyze tradeoffs and sensitivity
- Fill tables
- Export cal tables

The screenshot shows the CAGE Browser interface with the following components:

- Models Table:**

Name	Type	Inputs	Lower Output Limit	Upper Output Limit	Description
BSFC	MBC model	ECP, EngSpd, ICP, LOAD	-Inf	Inf	Created by hhu on 05-Jul-2016.
KIT1	MBC model	ECP, EngSpd, ICP, LOAD	-Inf	Inf	Created by hhu on 05-Jul-2016.
Lam	MBC model	ECP, EngSpd, ICP, LOAD	-Inf	Inf	Created by hhu on 05-Jul-2016.
RF1	MBC model	ECP, EngSpd, ICP, LOAD	-Inf	Inf	Created by hhu on 05-Jul-2016.
SpkAdv	MBC model	ECP, EngSpd, ICP, LOAD	-Inf	Inf	Created by hhu on 05-Jul-2016.
TAP	MBC model	ECP, EngSpd, ICP, LOAD	-Inf	Inf	Created by hhu on 05-Jul-2016.
TEXH	MBC model	ECP, EngSpd, ICP, LOAD	-Inf	Inf	Created by hhu on 05-Jul-2016.
TSPEED	MBC model	ECP, EngSpd, ICP, LOAD	-Inf	Inf	Created by hhu on 05-Jul-2016.
Torque	MBC model	ECP, EngSpd, ICP, LOAD	-Inf	Inf	Created by hhu on 05-Jul-2016.
WAP	MBC model	ECP, EngSpd, ICP, LOAD	-Inf	Inf	Created by hhu on 05-Jul-2016.
- Workflow:** A central panel titled "Use models to generate calibration" contains icons for "Import Models", "Optimization", "Tables and Tradeoff", "Feature", "Data set", and "Export Tables".
- Connections:** A diagram showing "ICP" and "LOAD" inputs connected to a model.
- BSFC Plot:** A 3D surface plot showing the relationship between EngSpd (0-5000), ECP (0-50), and BSFC (240-320). The X-axis is ECP and the Y-axis is EngSpd.

Calibrating Optimal Base Engine Control Tables

- Developing calibrations from response surface models

- Import response surface models
- **Run optimizations**
- Analyze tradeoffs and sensitivity
- Fill tables
- Export cal tables

The screenshot shows the CAGE Browser software interface. The main window displays a table of models and a central panel for creating an optimization. The 'Optimization' icon in the central panel is highlighted with a red circle. Below the central panel, there is a 'Connections' diagram showing 'ICP' and 'LOAD' inputs, and a 3D surface plot for the 'BSFC' model. The 3D plot shows the relationship between 'EngSpd' (X-axis, 0 to 5000) and 'ECP' (Y-axis, 0 to 50) on the horizontal plane, and 'BSFC' (Z-axis, 240 to 320) on the vertical axis. The surface plot shows a complex, non-linear relationship between these variables.

Name	Type	Inputs	Lower Output Limit	Upper Output Limit	Description
BSFC	MBC model	ECP, EngSpd, ICP, LOAD	-Inf	Inf	Created by hhu on 05-Jul-2016.
KIT1	MBC model	ECP, EngSpd, ICP, LOAD	-Inf	Inf	Created by hhu on 05-Jul-2016.
Lam	MBC model	ECP, EngSpd, ICP, LOAD	-Inf	Inf	Created by hhu on 05-Jul-2016.
RF1	MBC model	ECP, EngSpd, ICP, LOAD	-Inf	Inf	Created by hhu on 05-Jul-2016.
SpkAdv	MBC model	ECP, EngSpd, ICP, LOAD	-Inf	Inf	Created by hhu on 05-Jul-2016.
TAP	MBC model	ECP, EngSpd, ICP, LOAD	-Inf	Inf	Created by hhu on 05-Jul-2016.
TEXH	MBC model	ECP, EngSpd, ICP, LOAD	-Inf	Inf	Created by hhu on 05-Jul-2016.
TSPEED	MBC model	ECP, EngSpd, ICP, LOAD	-Inf	Inf	Created by hhu on 05-Jul-2016.
Torque	MBC model	ECP, EngSpd, ICP, LOAD	-Inf	Inf	Created by hhu on 05-Jul-2016.
WAP	MBC model	ECP, EngSpd, ICP, LOAD	-Inf	Inf	Created by hhu on 05-Jul-2016.

Calibrating Optimal Base Engine Control Tables

- Run optimizations

- Define objective
- Define constraints
- Determine operating point weights

Objective Function Table:

Name	Description	Type	Application Point Set
BSFC	Weighted sum of BSFC(ECP, ICP, LOAD, Speed)	Minimize	

Constraints Table:

Name	Description	Application Point Set	Status
BSFC_Boundary	Boundary constraint of BSFC(E...		
KIT1	KIT1(ECP, ICP, LOAD, Speed) <...		
LAM	LAM(ECP, ICP, LOAD, Speed) >...		
RF1	RF1(ECP, ICP, LOAD, Speed) <=...		
TEXH	TEXH(ECP, ICP, LOAD, Speed) <...		
TSPEED	TSPEED(ECP, ICP, LOAD, Speed)...		
ECPGrad	Gradient constraint of ECP over ...		
ICPGrad	Gradient constraint of ICP over (...)		

Free Variables Table:

Variable	ECP	ICP
Number of values:	155	155
(1)	2.343	0.139
(2)	10.095	0.609
(3)	19.03	1.228
(4)	19.322	1.239
(5)	18.574	1.246
(6)	19.303	1.852
(7)	15.673	4.692
(8)	1.495	0.125
(9)	13.403	0.747

Fixed Variables Table:

Variable	BSFC_w...	LOAD	Speed
Number of values:	155	155	155
(1)	35.2	0.275	750
(2)	3.4	0.275	1053.571
(3)	3.2	0.35	1053.571
(4)	5.3	0.425	1053.571
(5)	0.3	0.5	1053.571
(6)	0.2	0.575	1053.571
(7)	0.1	0.65	1053.571
(8)	1.1	0.2	1357.143
(9)	1.8	0.275	1357.143

Calibrating Optimal Base Engine Control Tables

- Run optimizations

- Evaluate optimization results
- Diagnose optimization convergence issues

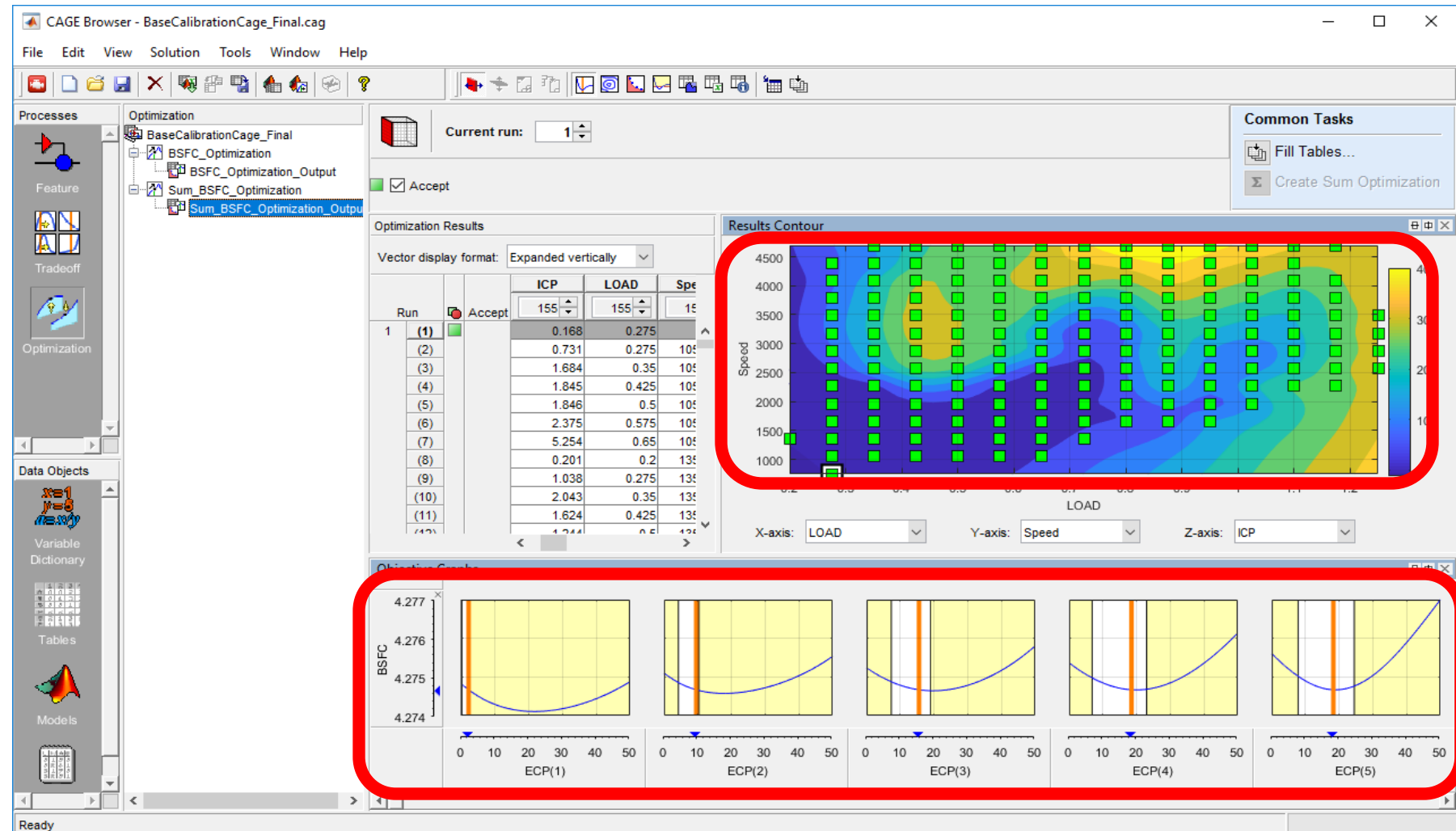

Calibrating Optimal Base Engine Control Tables

- Analyze tradeoffs and sensitivity

- Evaluate local sensitivity
- Determine if tradeoffs are needed

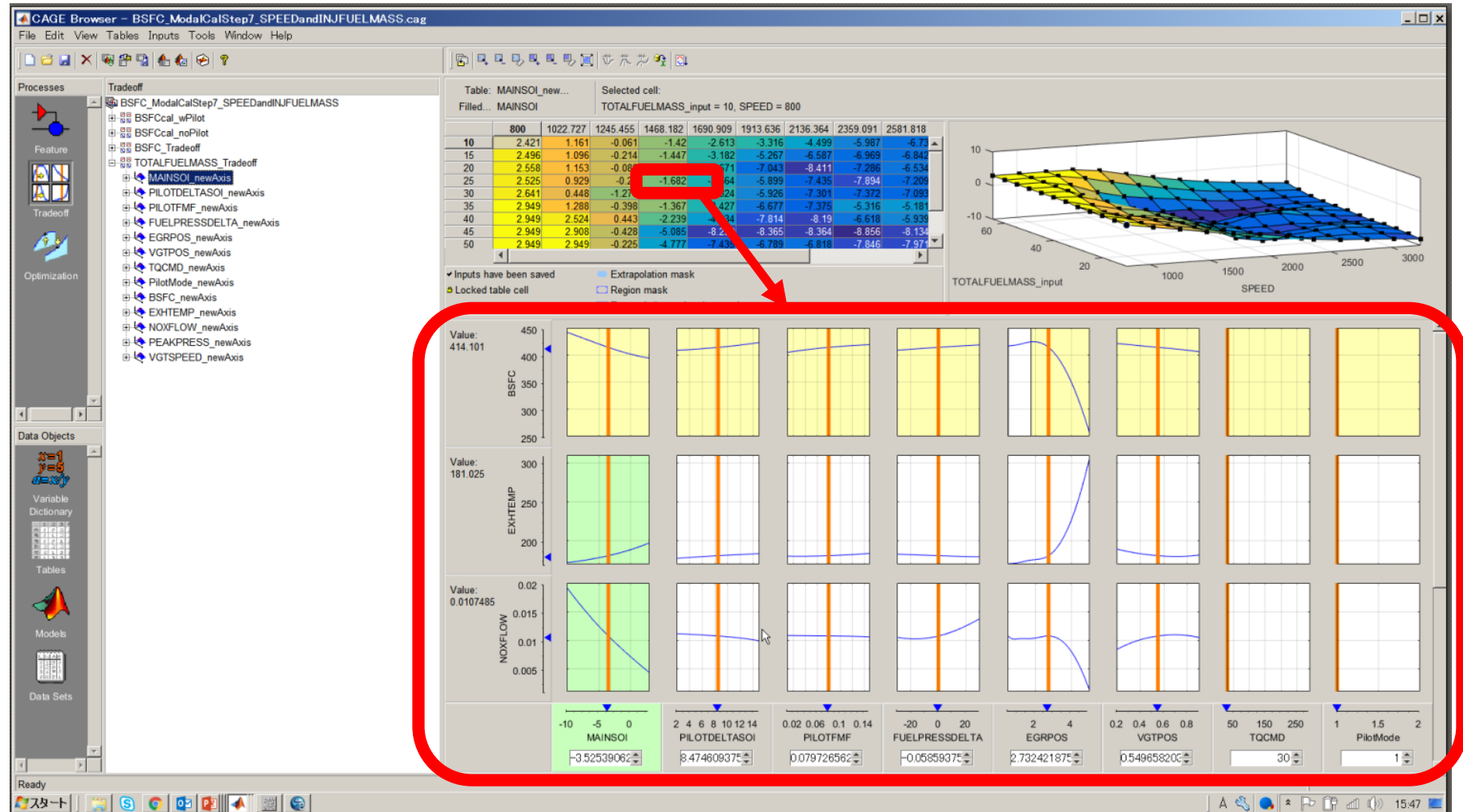

Calibration Generation Tool

- Fill tables

- Inspect surfaces
- Export to MATLAB, Excel or Cal tool

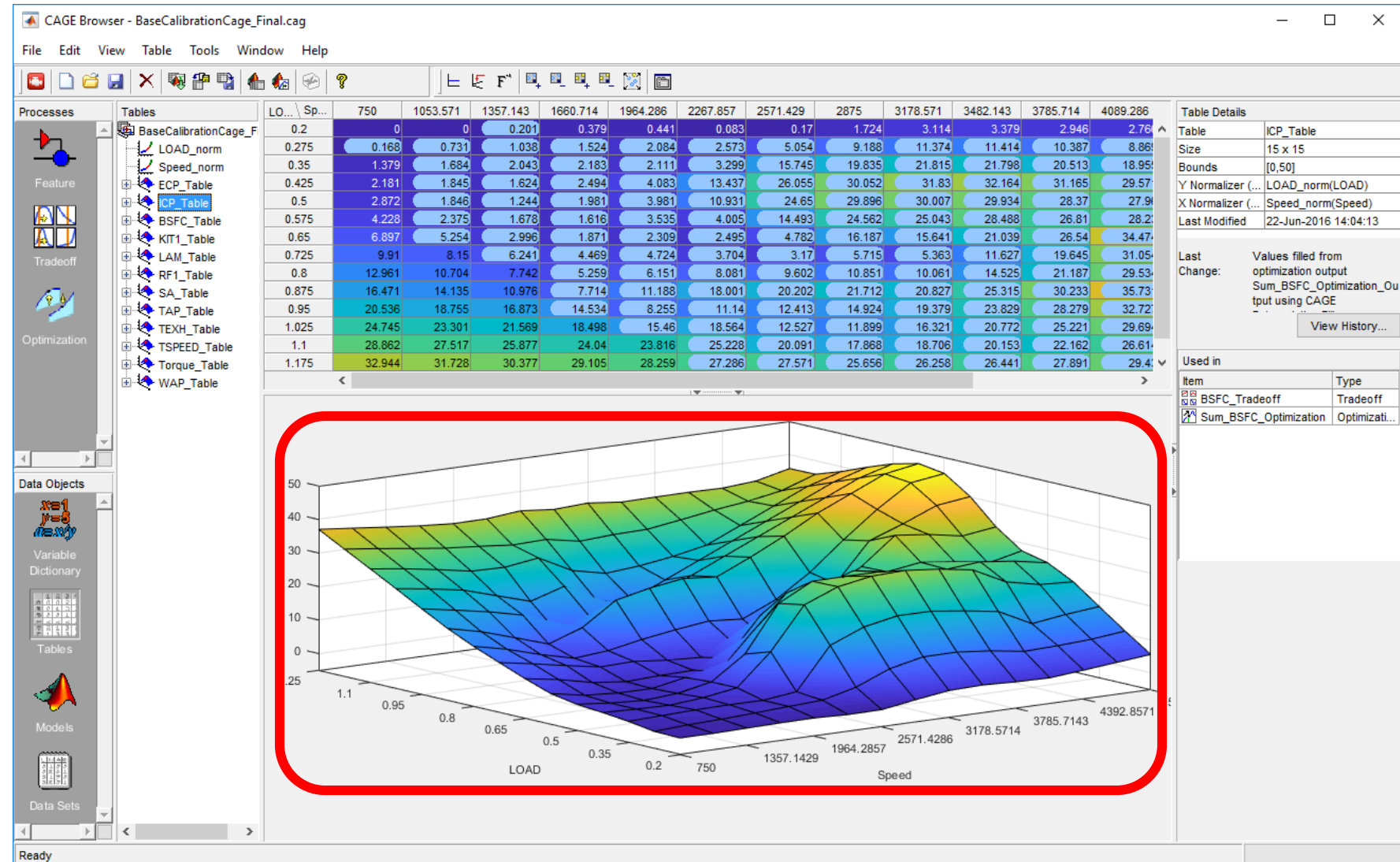

Optimal Base Calibrations Completed

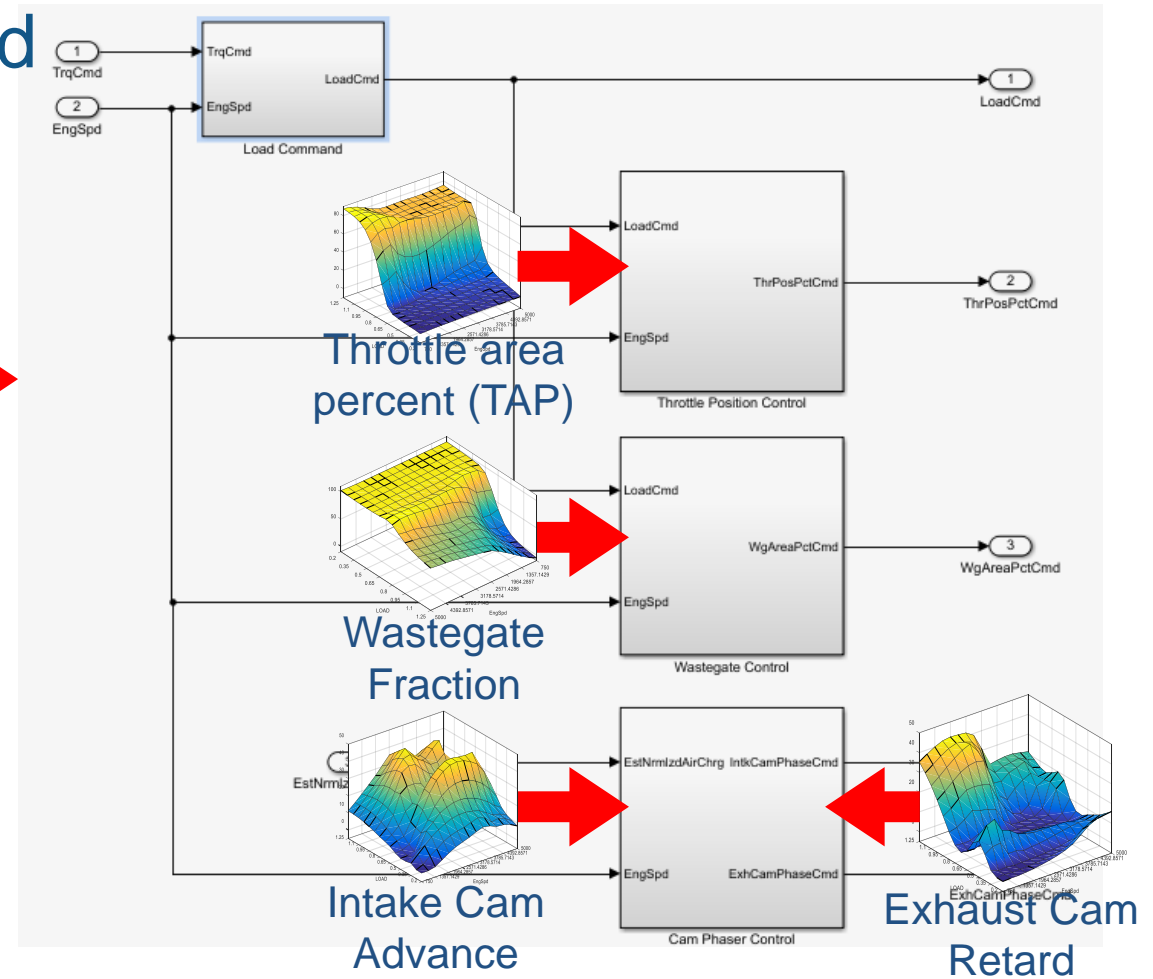
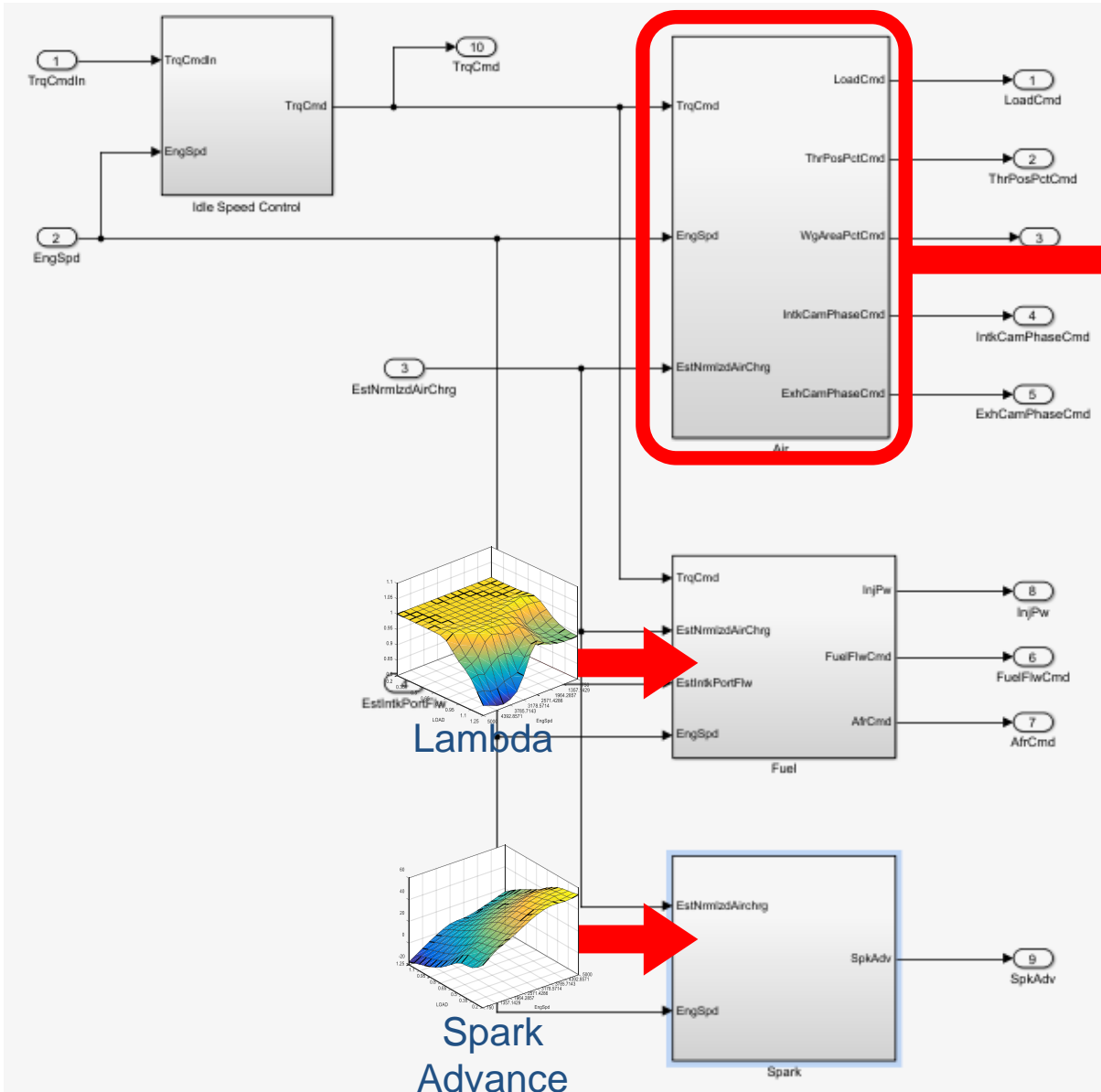

Calibrating Optimal Base Engine Control Tables

- Export and validate the result

- Optimal base engine control calibration workflow:
 - Creating the Design of Experiments
 - Gather the data
 - Fitting response surface models
 - Developing optimal base calibrations
 - **Export calibration to controller**

Use models to generate calibration

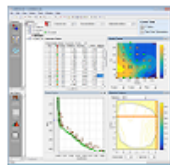

Optimization

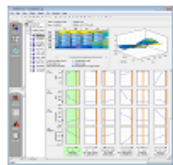

Tables and Tradeoff

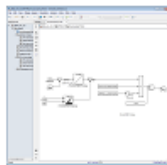

Feature

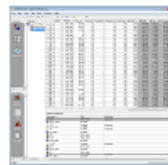

Data set

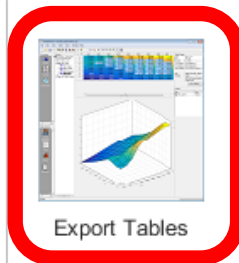

Export Tables

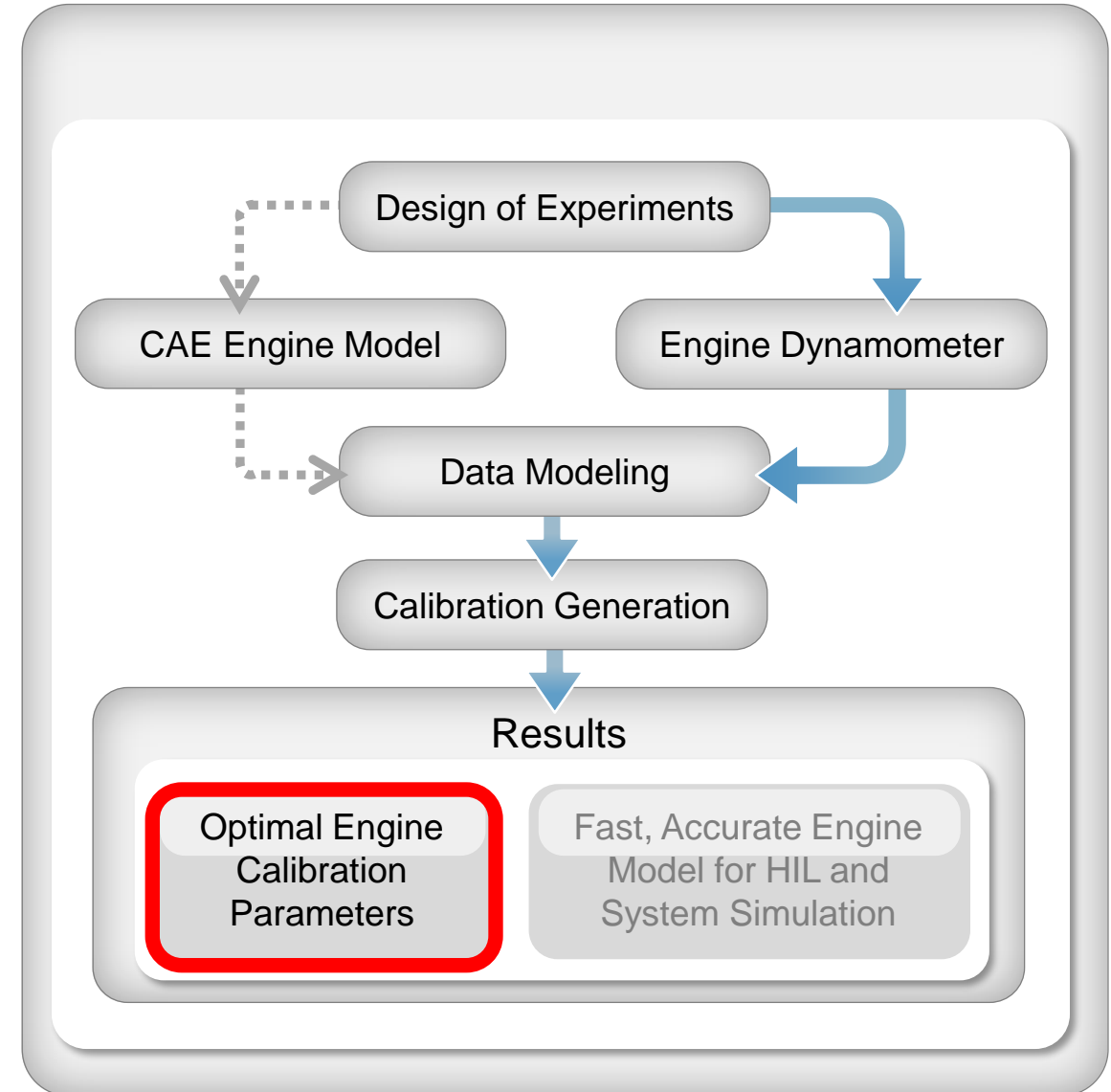

Export Tables to Calibration Tool

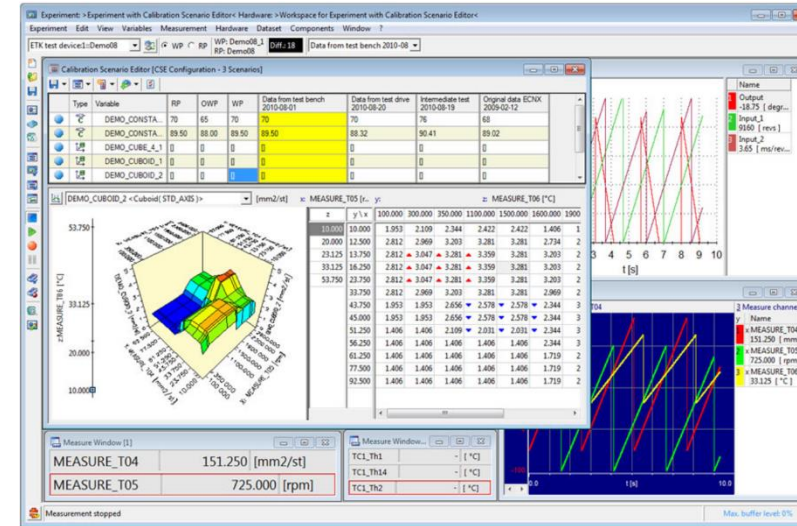
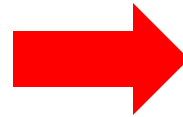
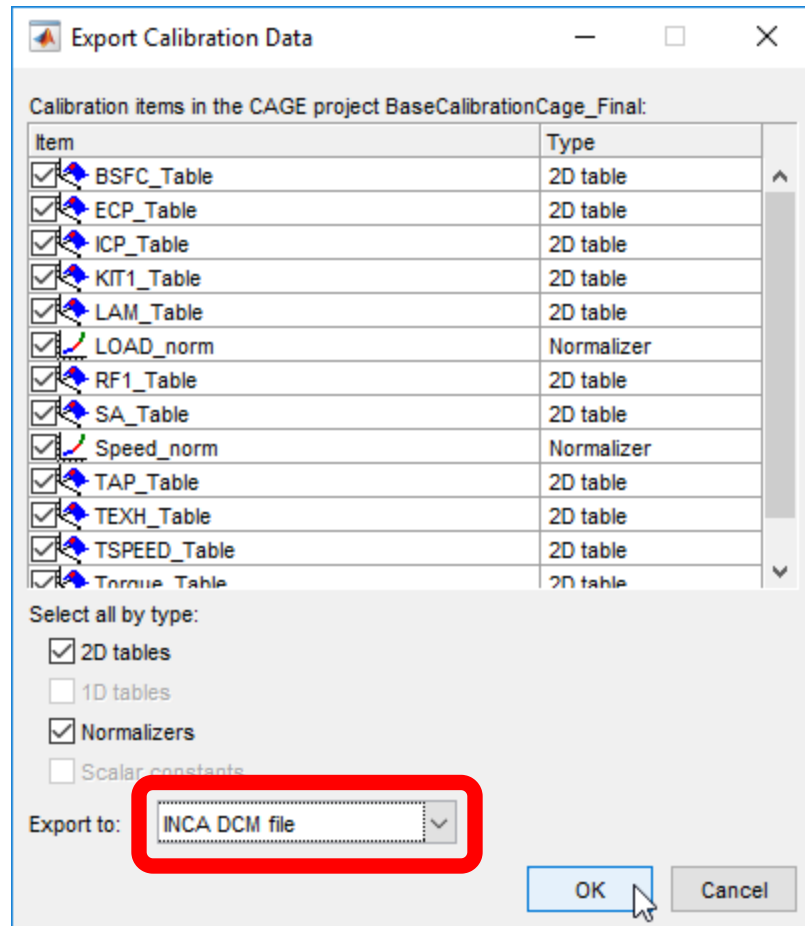

INCA

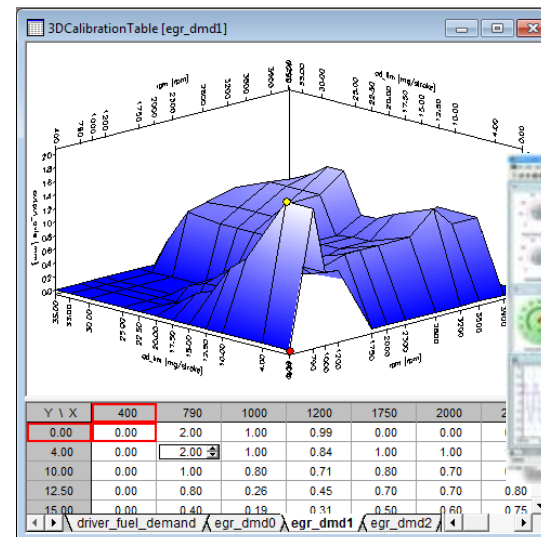

VISION



Calibrating Optimal Base Engine Control Tables

- Summary

- Optimal base engine control calibration workflow:
 - Creating the Design of Experiments
 - Gather the data
 - Fitting response surface models
 - Developing optimal base calibrations
 - Export calibration to controller

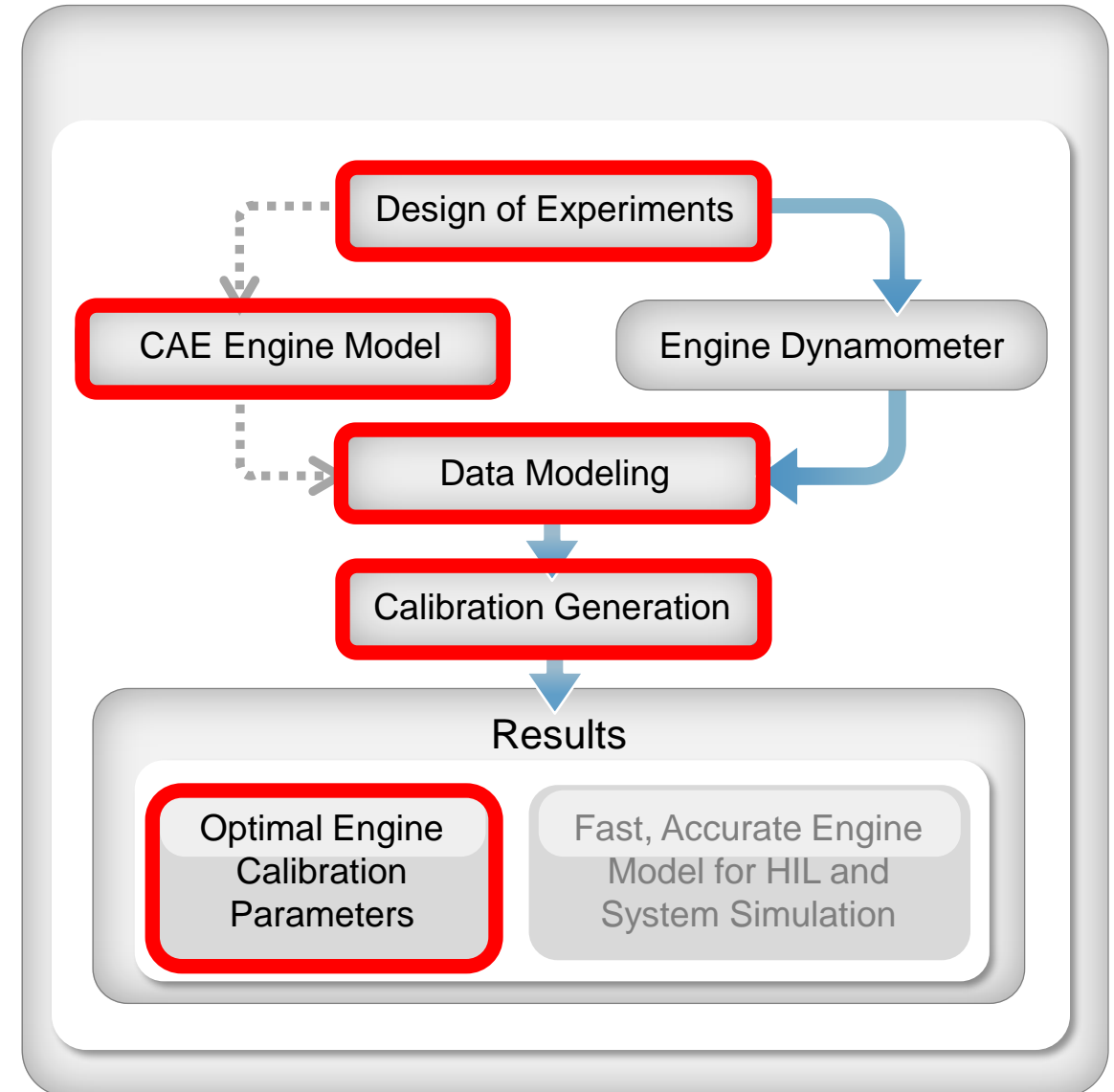

Key Take-Away's

- Engine model parameterization is a very non-trivial task
- Engine controller calibration is a very non-trivial task
- **MathWorks has tools to help make these two tasks more manageable**



Contact us to Learn More

- Scott Furry
(scott.furry@mathworks.com)
- Brad Hieb
(brad.hieb@mathworks.com)

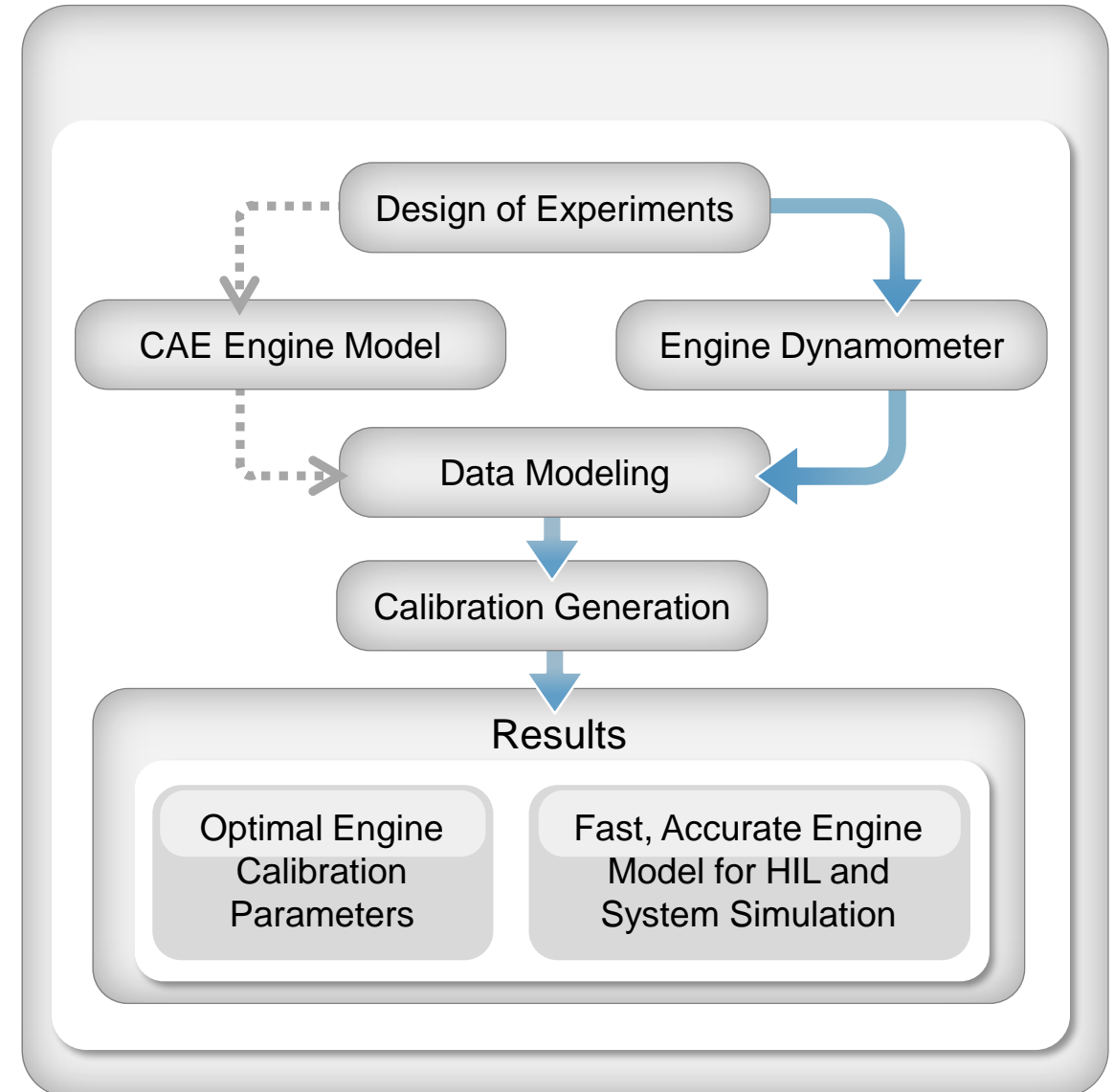

Q & A

